

OCS Report
MMS 2000-037

MOBIL LYDONIA CANYON BLOCK 312 No. 1 WELL

Geological and Operational Summary

Edited by:

Gary M. Edson
Donald L. Olson
Andrew J. Petty

U. S. Department of the Interior
Minerals Management Service
Gulf of Mexico OCS Region
Office of Resource Evaluation

New Orleans
May 2000

CONTENTS

Abbreviations, vi
Introduction, 1
Operational Summary, 2
Well Velocity Profile, 9
Lithologic Interpretation, 13
Biostratigraphy, 17
Formation Evaluation, 23
Geothermal Gradient, 28
Petroleum Geochemistry, 30
Company-submitted Data, 37
Selected References, 38

ILLUSTRATIONS

- Figure
1. Map of the North Atlantic offshore area showing well locations, 3
 2. Location plat for the Mobil Block 312 No. 1 well on the OCS Lydonia Canyon NK 19-12 protraction diagram, 4
 3. Daily drilling progress for the Mobil Lydonia Canyon Block 312 No. 1 well, 5
 4. Casing diagram for the Mobil Lydonia Canyon Block 312 No. 1 well, 7
 5. Well velocity profile for the Mobil Lydonia Canyon Block 312 No. 1 well, plotted against depth, 10
 6. Well velocity profile for the Mobil Lydonia Canyon Block 312 No. 1 well, plotted against two-way travel time, 11
 7. Columnar chart of the lithology, biostratigraphy, and paleobathymetry of the Mobil Lydonia Canyon Block 312 No. 1 well, 14
 8. Well temperatures and geothermal gradient for the Mobil Lydonia Canyon Block 312 No. 1 well, 29
 9. Relationships among coal rank, percent R_o , TAI, spore color, and thermal zones of hydrocarbon generation, 31
 10. Graph of kerogen types, total organic carbon (TOC), and organic thermal maturity for the Mobil Lydonia Canyon Block 312 No. 1 well, 32
 11. Burial diagram for the Mobil Lydonia Canyon Block 312 No. 1 well, 36

TABLES

Table	1. Well statistics, 6
	2. Well velocity data, 9
	3. Well velocity intervals, 12
	4. Well logs, 23
	5. Well log interpretation summary, 24
	6. Sidewall core summary, 25
	7. Conventional core summary, 25
	8. Hydrocarbon shows, 27
	9. Total organic carbon analysis, 33

ABBREVIATIONS

API	-- American Petroleum Institute
bbl	-- barrels
BOP	-- Blowout preventer
CNL	-- Compensated neutron log
CPI	-- Carbon Preference Index
COST	-- Continental Offshore Stratigraphic Test
DST	-- drill stem test
EQMW	-- equivalent mud weight
FDC	-- compensated formation density log
FEL	-- from east line
FNL	-- from north line
FSL	-- from south line
FWL	-- from west line
k	-- permeability
KB	-- kelly bushing
LS	-- limestone
m	-- meter (s)
md	-- millidarcy
MYBP	-- million years before present
OCS	-- Outer Continental Shelf
ppf	-- pounds per foot
ppg	-- pounds per gallon
ppm	-- parts per million
psi	-- pounds per square inch
R _o	-- vitrinite reflectance
SS	-- sandstone
Sw	-- water saturation
TAI	-- thermal alteration index
TD	-- total depth
TIOG	-- threshold of intense oil generation
TOC	-- total organic carbon
UTM	-- Universal Transverse Mercator
φ	-- porosity

INTRODUCTION

The Mobil Lydonia Canyon (LC) Block 312 No. 1 well was the fourth of the eight industry wildcat wells drilled on Georges Bank. Spudded on December 8, 1981, this well is about 19 miles to the southwest of the Continental Offshore Stratigraphic Test (COST) G-2 well. The Mobil LC Block 312 No. 1 well was drilled by a semi-submersible rig in 259 feet of water on the continental shelf about 125 miles east-southeast of Nantucket Island and about 20 miles northwest of the shelf edge.

Mobil Exploration and Producing, Inc. was the designated operator for the well, and the company's drilling target was a Middle Jurassic (Callovian) reef, inferred from seismic data at 2.9 seconds depth, two-way travel time, interpreted to be about 15,800 feet below sea level. Well data showed that the seismic feature is not a reef, but consists of tight, micritic limestone of Triassic age within a thick section of micritic, pelletal, and oolitic limestone. Mobil drilled the LC Block 312 No. 1 well to 20,000 feet, reaching TD on June 13, 1982. The rig was released on June 27.

This report relies on geologic and geophysical data provided to the Minerals

Management Service (MMS) by Mobil, according to Outer Continental Shelf (OCS) regulations and lease stipulations. The data were released to the public after the Lydonia Canyon Block 312 lease No. OCS-A-0200 expired on January 31, 1985. Interpretations of the data contained in this report are those of MMS and may differ from those of Mobil. Depths are relative to Kelly bushing unless otherwise stated. Although the operator reported the well's measured depth to be 20,000 feet, some well data show depths to 19,990 feet.

The material contained in this report is from unpublished, undated MMS internal interpretations. No attempt has been made to provide more recent geologic, geochemical, or geophysical interpretations or data, published or unpublished.

This report is initially released on the Minerals Management Service Internet site <http://www.gomr.mms.gov>, and, together with the other Georges Bank well reports, on a single compact disk (CD). At a later date, additional technical data, including well "electric" logs will be added to the CD.

OPERATIONAL SUMMARY

The Mobil Lydonia Canyon (LC) Block 312 No. 1 well (figure 1) was drilled by the *Rowan Midland* semisubmersible drilling rig to a total depth of 20,000 feet. However, some submitted data show depths to 19,990 feet. Mobil Exploration and Producing Services, Inc. was designated as operator. The well's location within the lease block is shown in figure 2. Daily drilling progress is shown in figure 3, and well and drilling information are summarized in table 1. A casing and abandonment diagram is shown in figure 4. Drilling stipulations required the operator to provide MMS with well logs, lithologic samples, core samples, geologic information, and operational reports.

The well was spudded on December 8, 1981, in 259 feet of water. The surface hole was drilled and 30-inch type 5-L (456 and 309 lbs/ft) casing was set at 551 feet and cemented with 900 sacks of class H cement. The riser was connected and the shoe tested to 500 psi with 9.0 ppg mud. A formation integrity test was successful to 225 psi (12.4 ppg EQMW), and a blowout preventer assembly was connected and tested. The interval from the 30-inch casing shoe to 1,319 feet was drilled with a rate of penetration of 60 to 70 feet per hour and then reamed to 26 inches. The 20-inch casing was set at 1,293 feet and cemented with 828 sacks of class G cement with bentonite and 500 sacks of class G cement with 1-percent sodium chloride.

The interval from the 20-inch casing shoe to 4,952 feet was drilled in 111 hours with

six bits with a rate of penetration averaging 33 ft/hr, ranging from 700 to 8 feet/hr. The section consisted of soft clay and argillaceous and highly calcareous shale sections. Background gas averaged one unit with a maximum of five units in soft clay at 1,800 feet. Caustic gel mud was used with weights varying from 8.9 to 9.0 ppg.

The 13 3/8-inch type S-95 (72 lbs/ft) casing was run to 4,917 feet and cemented with 1,375 sacks of class H cement. The shoe was tested to 1,500 psi, drilled out, and a formation integrity test to 1,176 psi with 9.0 ppg mud (13.6 ppg EQMW) was performed.

The interval from the 13 3/8-inch casing shoe to 13,014 feet was drilled in 587 hours with 13 bits, and rates of penetration averaged 13.9 ft/hr, ranging from 7 to 600 ft/hr. The section consisted predominantly of siltstone with sections of sand between 5,000 and 6,500 feet and sections of limestone from 7,000 to 8,200 feet and 11,350 to 13,000 feet. Sidewall cores were also obtained in this interval. Background gas averaged one to two units, with no significant gas shows. Caustic gel mud was used with weights varying from 8.9 to 9.1 ppg.

The 9 5/8-inch type S-95 (53.5 lbs/ft) casing was run to 12,942 feet and cemented with 788 sacks of class H cement. The initial shoe test was unsatisfactory and the cause was determined to be unset cement because too much retarder (HR-7) was used. The

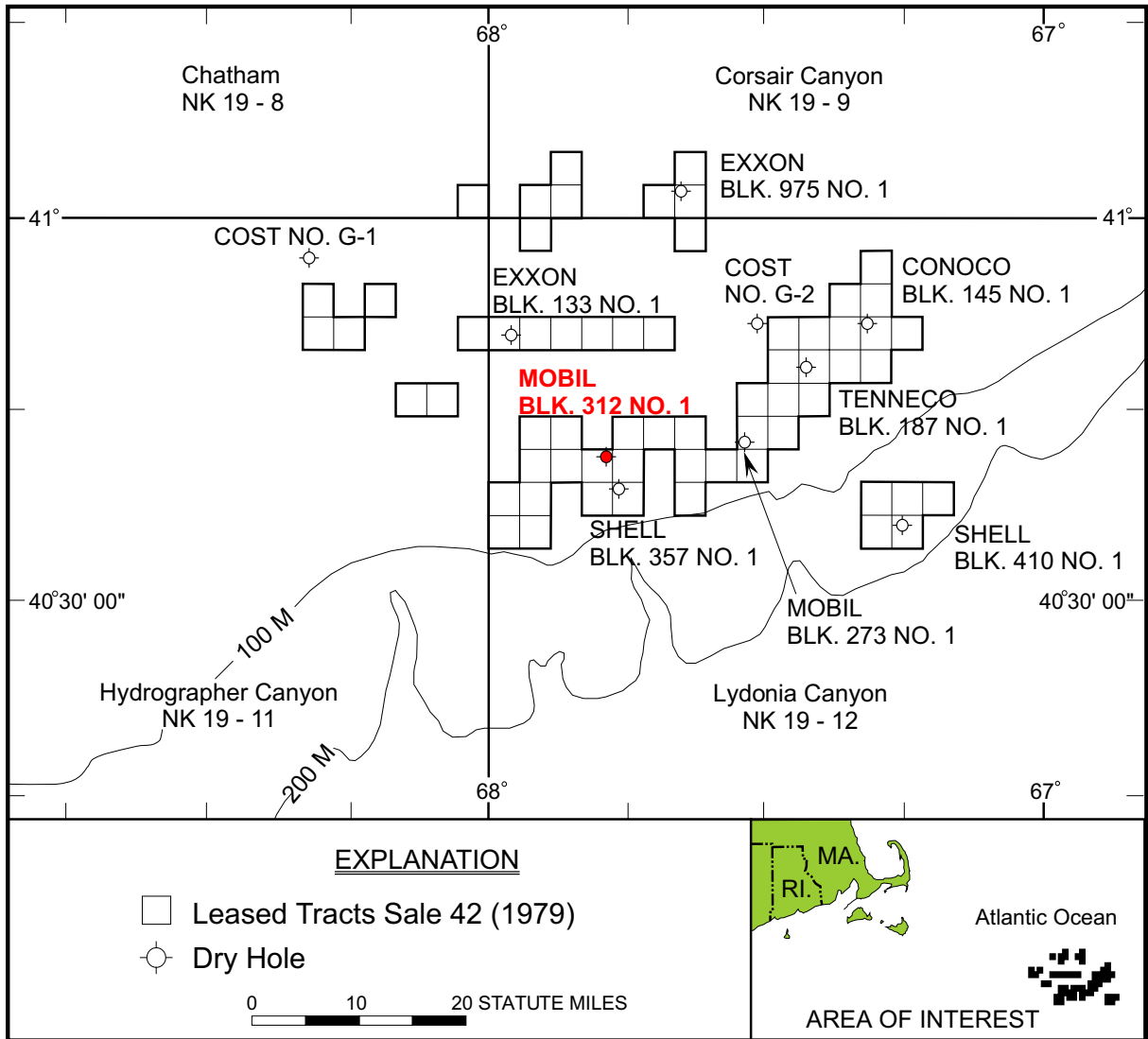

Figure 1. Map of the North Atlantic offshore area showing well locations. The Mobil Lydonia Canyon Block 312 No. 1 well is highlighted in red. Bathymetry is in meters.

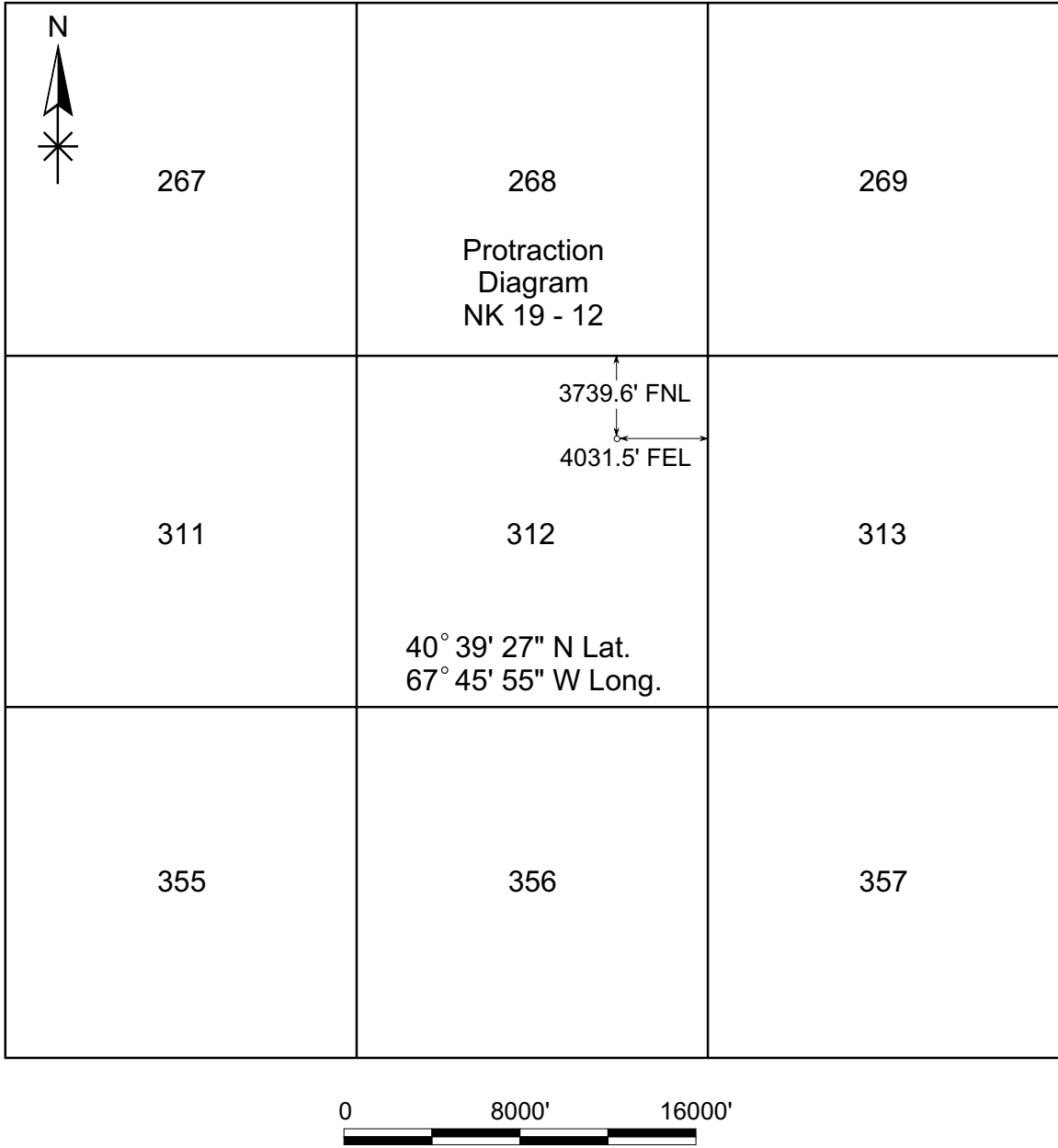

Figure 2. Location plat for the Mobil Block 312 No. 1 well on the OCS Lydonia Canyon NK 19-12 protraction diagram.

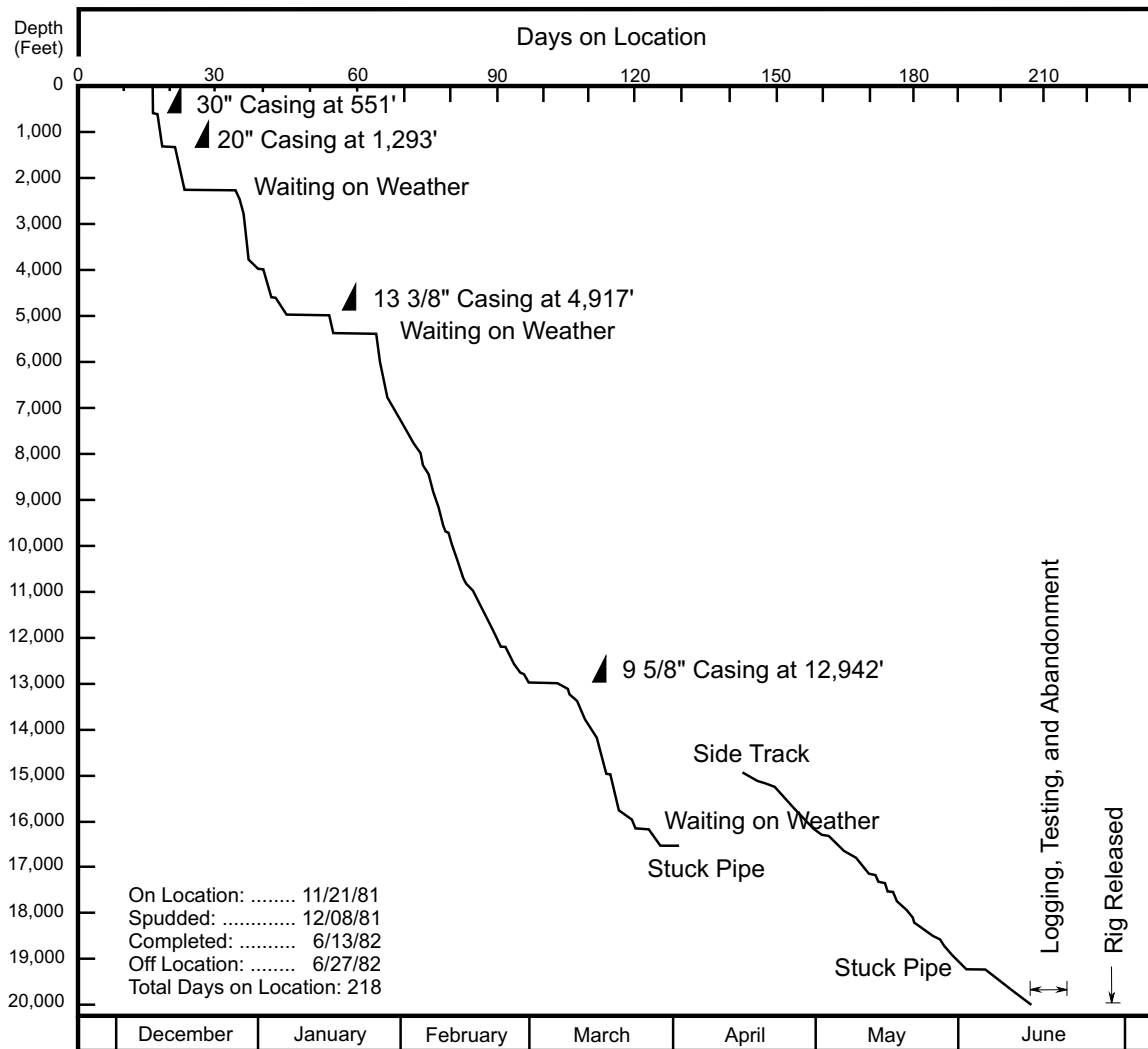

Figure 3. Daily drilling progress for the Mobil Lydonia Canyon Block 312 No. 1 well.

Table 1. Well statistics

Well identification:	API No. 61-040-00004 Lease No. OCS-A-0200
Surface location:	Lydonia Canyon NK19-12 LC Block 312 3,739.6 feet FNL 4,031.5 feet FEL Latitude: 40 ⁰ 39' 27" N Longitude: 67 ⁰ 45' 55" W UTM coordinates: X = 604,431 m Y = 4,501,279 m
Bottomhole location:	Side track No. 3, 57.7 feet N and 271.6 feet E of surface location
Proposed total depth:	18,500 feet, amended to 20,000 feet
Measured depth:	20,000 feet
True vertical depth:	19,997 feet
Kelly bushing elevation:	89 feet
Water depth:	259 feet
Spud date:	December 8, 1981
Reached TD:	June 13, 1982
Off location:	June 27, 1982
Final well status:	Plugged and abandoned

Note: All well depths indicated in this report are measured from the kelly bushing, unless otherwise indicated. Mean sea level is the datum for the water depth.

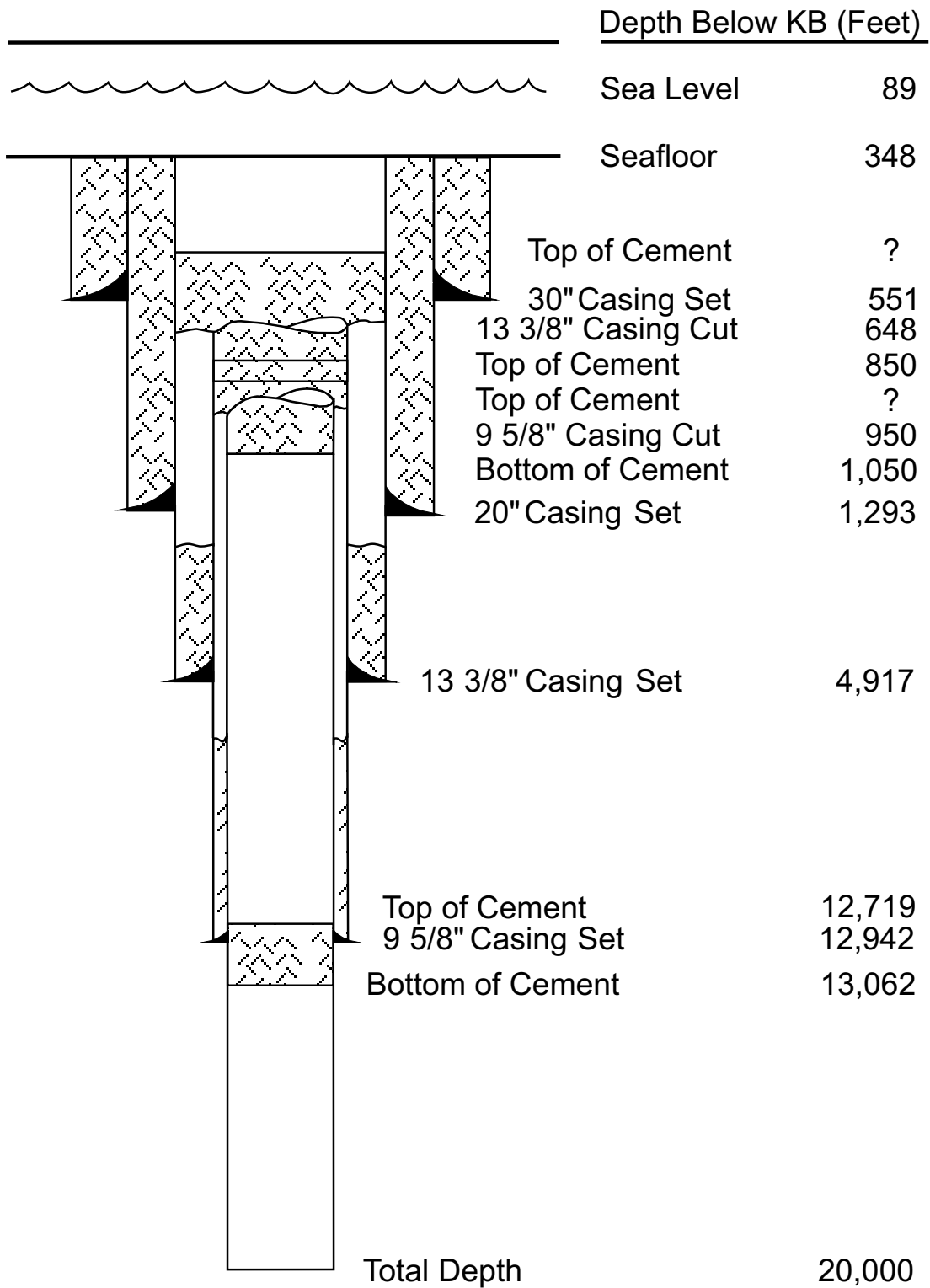

Figure 4. Casing diagram for the Mobil Lydonia Canyon Block 312 No. 1 well.

cement hardened after an additional waiting period (14 hours) and the shoe tested to 5,000 psi. After drilling out the shoe, a formation integrity test of 4,976 psi (16.5 ppg EQMW) with 9.1 ppg mud was performed.

The interval from the 9 5/8-inch casing shoe to 16,521 feet was drilled in 283 hours with eight bits, and rates of penetration averaged 12.6 ft/hr, ranging from 5 to 31 ft/hr. The section consisted entirely of limestone. No background gas was observed; however, trip gas in excess of 30 units was detected at 14,920, 15,000, and 16,230 feet. Caustic gel mud was used with weights varying from 9.0 to 12.1 ppg.

Below 15,800 feet, various hole problems were encountered: drag at connections, increased torque, and hole filling that required reaming after tripping and connections to get back to bottom. At 16,521 feet, the bottomhole assembly became stuck, and circulation was lost. A back-off was attempted, and none of the bottomhole assembly was recovered. The hole was plugged back to 15,300 feet, and a sidetrack was attempted at 15,500 feet. The hole was plugged back again to 14,800 feet, and a second sidetrack attempted at 14,982 feet. A third sidetrack attempt was finally successful at 15,079 feet. A conventional core, from 15,810 to 15,840 feet, was recovered.

The interval from 15,104 to 20,000 feet was drilled in 685 hours with 15 bits, and the rate of penetration averaged 7.1 ft/hr. The kickoff procedure required an

additional three bits, which were not included above. The section consisted entirely of limestone, and no background gas and negligible trip gas were observed. At 17,400 feet, the drill pipe became stuck while tripping out because of keyseat development during vertical profile recovery after the sidetrack was initiated. A back-off was performed and all pipe was subsequently recovered. Lignosulfonate gel mud was used with weights varying from 14.0 to 14.5 ppg.

One 30-foot conventional core was cut in limestone at 15,810 feet. No flow tests were attempted. The well pressure gradient is described in the **Formation Evaluation** chapter.

The first well plug was set at 12,719 to 13,062 feet depth with 273 sacks of cement. The plug was pressure tested, and the 9 5/8-inch casing was cut at 950 feet. The second plug was set with 125 sacks at 1,050 feet, bottom of cement. This plug failed a pressure test, and another 100 sacks were set on top (top of cement about 850 feet). After a successful pressure test, the 13 3/8-inch casing was cut at 648 feet, and a 500-sack plug was set. The 20- and 30-inch casings were cut at an unknown depth. The diverter and blowout preventer were pulled. Anchors were pulled, and the *Rowan Midland* moved off location on June 27, 1982.

John Chance and Associates conducted a post-abandonment site survey with sidescan radar.

WELL VELOCITY PROFILE

Schlumberger, Ltd. Wireline Testing ran a velocity checkshot survey between 1,203 and 18,418 feet in the Mobil LC Block 312 No. 1 well. The checkshot data, together with that for the other nine wells drilled on Georges Bank, were given to Velocity Databank, Inc. at their request after all leases had been relinquished or had expired. Velocity Databank calculated interval, average, and RMS velocities,

plotted time-depth curves, and tabulated the data. Table 2 presents well depth, two-way travel time, and the calculated velocities for the Mobil LC Block 312 No. 1 well. Figures 5 and 6 show interval velocity, average velocity, and RMS velocity plotted against depth and against two-way travel time. All depths are subsea.

Table 2. Well velocity data

Depth (Feet)	Two-Way Travel Time (Seconds)	Interval Velocity (Feet/Sec.)	Average Velocity (Feet/Sec.)	Rms Velocity (Feet/Sec.)
1,203	0.418	5,755	5,755	5,755
3,901	1.156	7,311	6,749	6,789
4,841	1.356	9,400	7,140	7,234
5,911	1.564	10,288	7,558	7,710
6,911	1.744	11,111	7,925	8,127
8,976	2.064	12,906	8,697	9,035
9,911	2.206	13,168	8,985	9,356
10,960	2.356	13,986	9,303	9,717
11,940	2.484	15,312	9,613	10,081
12,860	2.600	15,862	9,892	10,408
12,910	2.608	12,499	9,900	10,415
13,910	2.714	18,867	10,250	10,869
14,160	2.744	16,666	10,320	10,949
14,689	2.798	19,592	10,499	11,179
14,909	2.820	20,000	10,573	11,275
15,139	2.842	20,909	10,653	11,381
15,417	2.872	18,533	10,736	11,478
15,626	2.892	20,900	10,806	11,570
15,905	2.918	21,461	10,901	11,695
16,173	2.944	20,615	10,987	11,803
16,591	2.982	21,999	11,127	11,988
16,991	3.018	22,222	11,259	12,161
17,389	3.060	18,952	11,365	12,279
17,788	3.100	19,950	11,476	12,409
18,187	3.138	20,999	11,591	12,548
18,418	3.158	23,100	11,664	12,642

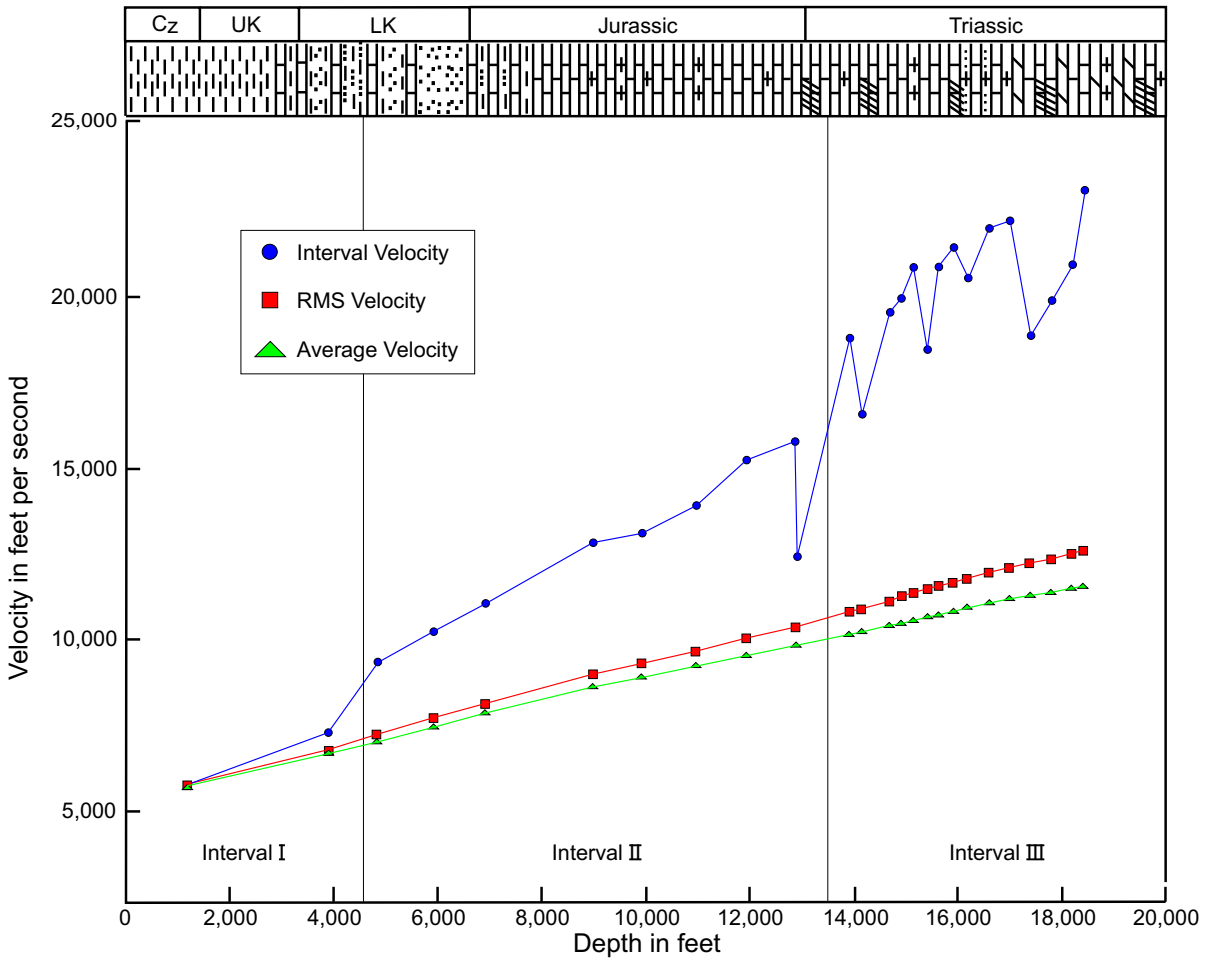

Figure 5. Well velocity profile for the Mobil Lydonia Canyon Block 312 No. 1 well, plotted against depth, with biostratigraphic ages and generalized lithologies. Intervals are explained in text.

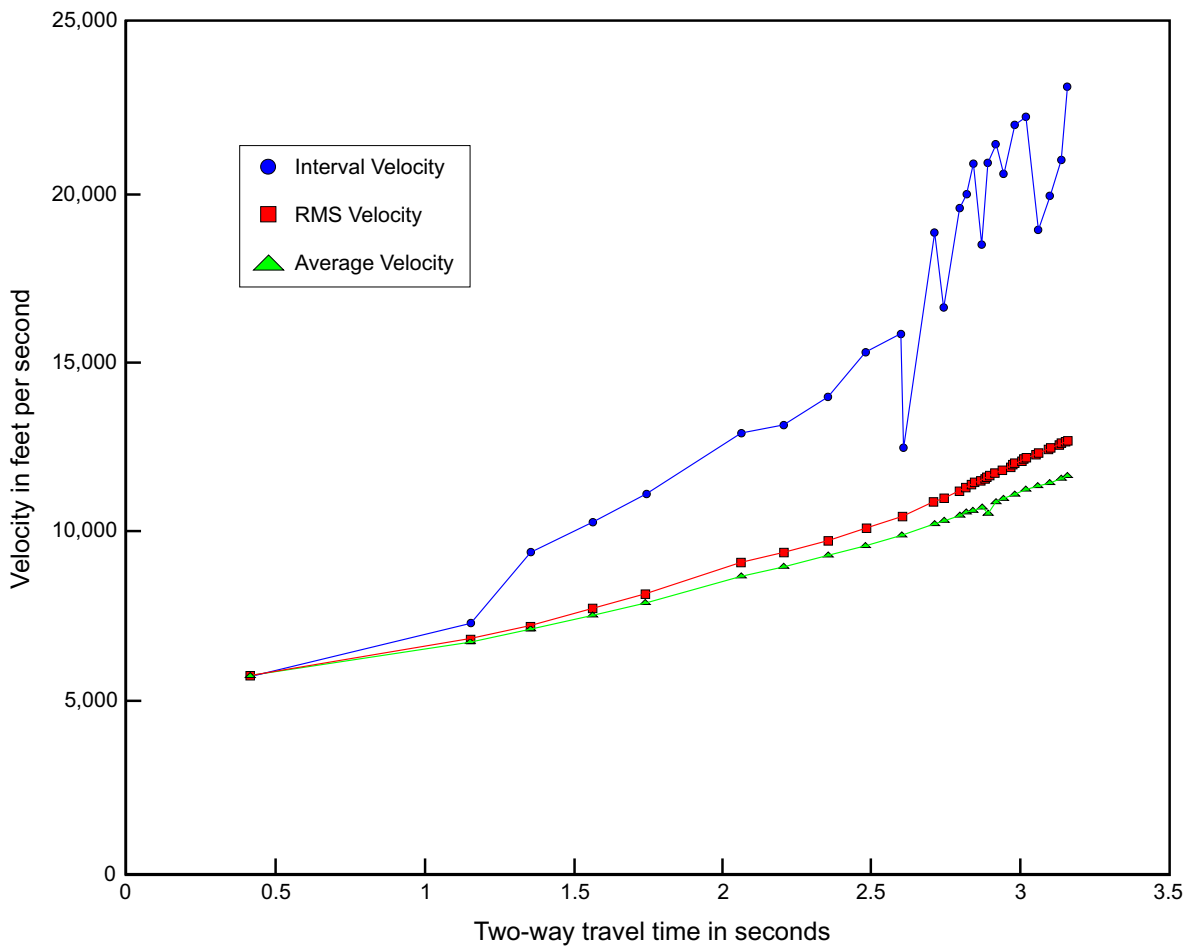

Figure 6. Well velocity profile for the Mobile Lydonia Canyon Block 312 No. 1 well, plotted against two-way travel time.

A lithologic column is also shown in figure 5, and three velocity intervals are indicated, which generally correlate with

three distinct lithologic intervals penetrated by the well:

Table 3. Well velocity intervals

Interval	Depth Range (Feet)	Interval Velocity Range (Feet/Second)	Average Interval Velocity (Feet/Second)
I	0-4,500	5,755-7,311	6,533
II	4,500-13,500	9,400-15,862	12,726
III	13,500-20,000	16,666-23,100	20,318

Interval I This interval is identified on the basis of low velocities, and it generally correlates with Cenozoic and Upper and Lower Cretaceous lithologies dominated by shale.

Interval II This interval is identified on the basis of intermediate velocities, and it generally agrees with Lower Cretaceous

mixed lithologies and Jurassic limestone.

Interval III This interval is identified on the basis of high, but variable, velocities, and it generally correlates with Triassic limestone, dolomite, and anhydrite.

LITHOLOGIC INTERPRETATION

Taken and adapted from A. C. Giordano, MMS internal report

Well cuttings were collected at 30-foot intervals from 540 to 13,020 feet and at 10-foot intervals to total depth, 20,000 feet, in the Mobil LC Block 312 No. 1 well. Sample quality ranged from good to excellent, based on amounts of cavings and degree of washing. Additional lithologic control was provided by a conventional core taken in the side track of the well from 15,810 to 15,840 feet and analysis of the core by Mobil Exploration and Producing Services, Inc.

The lithologic descriptions in this report are interpretations derived mainly from examination of drill cuttings, supplemented by thin section studies. Depths of lithologic boundaries are adjusted with reference to “electric” and “mud” logs. All depths are from kelly bushing. Rocks penetrated are divided into gross lithologic-stratigraphic units, and a lithologic column appears as figure 7. Interpretation of depositional environments is based on occurrence of lithologic indicators such as coal and oolites, and on nannoplankton and depth-sensitive foraminifera. Relative abundances of terrigenous versus marine-derived palynomorphs are also indicators of shoreline proximity and sea-level variation.

LITHOLOGIC DESCRIPTIONS

From 540 to 660 feet, the section consists of a reworked sandy marine pebble conglomerate. The sand is medium to fine grained, clear to frosty, and is subrounded

to subangular. A mixed assemblage of fossil pelecypods, gastropods, foraminifera, and echinoid spine fragments is present throughout this interval. From 660 to 1,350 feet, the samples consist of gray to brown to green, soft, sticky, noncalcareous clay with a trace of quartz grains. The clay is fossiliferous with many planktonic and benthonic foraminifera, as well as gastropods and pelecypod fragments. The fossil assemblage indicates deposition in a shallow-marine environment.

There is a 140-foot-thick section of green-gray glauconite from 1,350 to 1,490 feet associated with the unconformity between the Cretaceous and Tertiary sediments.

The interval from 1,490 to 2,380 feet consists of white to gray, soft to firm, friable, moderately sorted, micaceous, noncalcareous siltstone with interbedded sand and clay, traces of pyrite, and fossil fragments of Late Cretaceous age. The depositional environment ranged from littoral, restricted marine to middle shelf.

From 2,380 to 2,880 feet, the section consists of light- to medium-gray clay that is soft to firm and contains traces of siltstone. The clay is calcareous with evenly dispersed fossiliferous material. A restricted marine environment is indicated by the fossils and their decreased diversity.

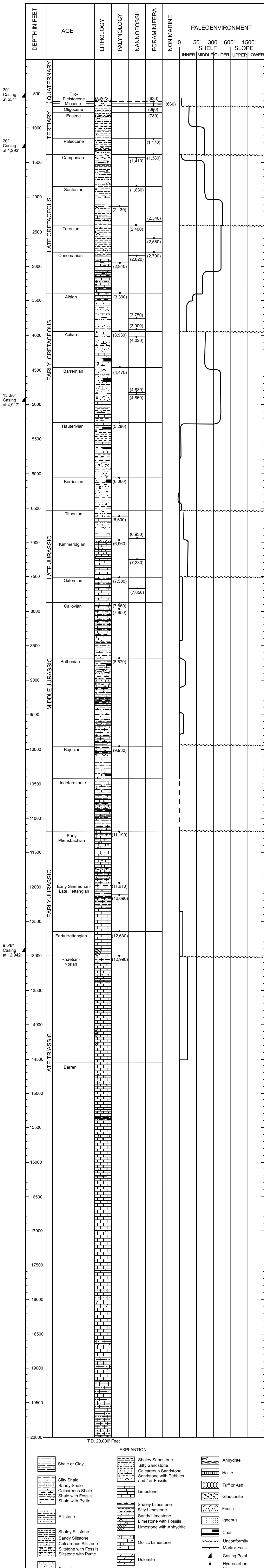

Figure 7. Columnar chart of the lithology, biostratigraphy, and paleobathymetry of the Mobil Lydonia Canyon Block 312 No. 1 well. Lithologic interpretations from examination of well cuttings; lithologic breaks listed in Biostratigraphy chapter. Within columns, depths refer to uppermost occurrence of index fossils listed in Biostratigraphy chapter. Stage tops based on paleontology. Biostratigraphy and bathymetric interpretations become less reliable with increasing depth.

From 2,880 to 3,500 feet, the section consists of light-gray to white to pinkish, microcrystalline, sucrosic, slightly fossiliferous limestone. The limestone is interbedded with medium- to coarse-grained calcareous sandstone with subrounded to rounded grains, and gray calcareous siltstone with traces of glauconite, lignite, pyrite, and fossil fragments of Late Cretaceous age. The micritic limestone was deposited as a fluctuating shallow marine sequence.

From 3,500 to 4,980 feet, the interval consists of clear to light-gray to brown, fine- to medium-grained, round to subrounded, moderately sorted, calcareous-cemented, nonporous, hard sandstone. It also contains small amounts of limestone and siltstone and traces of lignite, pyrite, mica, and fossil fragments of Early Cretaceous age. The interval represents a deltaic depositional sequence on the mid- to outer-shelf.

The interval from 4,980 to 5,750 feet consists of dull red to brown to medium-gray, firm to moderately hard, slightly calcareous, impermeable shale. This section is also interbedded with white to light-gray, moderately hard, microcrystalline, biomicrite limestone, with traces of pyrite, mica, and coal. The environment of deposition is a restricted marine lagoonal or bay sequence.

The section from 5,750 to 6,480 feet consists of predominately fine- to medium-grained, poorly indurated calcareous sandstone with white and clear and subrounded to well-rounded grains. The sandstone is interbedded with light- to dark-gray, firm to brittle, platy, and blocky

fragmented shale. The shale contains traces of limestone, quartz, coal, pyrite, and glauconite. This Early Cretaceous section is a nonmarine to restricted marine depositional section.

From 6,480 to 7,000 feet, the section consists primarily of white to dark-gray, soft to moderately hard, argillaceous, poorly sorted, vitreous to earthy, calcareous siltstone, which has a gradational contact with the overlying sandy sequence. The siltstone has no visual porosity, and is interbedded with oolitic limestone, shale, and friable sand with traces of coal, pyrite, glauconite, and mica. A sharp resistivity kick on the E-log at 6,550 feet, also seen in the Exxon Block 133 No. 1 well, marks the lithologic boundary between the Early Cretaceous sediments above and the Late Jurassic below. From 6,920 to 7,000 feet, limestone recrystallized to dolomite, perhaps owing to meteoric alteration, overlies an oolitic and micritic, slightly fossiliferous limestone section. Ooid interiors are partially filled with calcite, leaving some intraparticle porosity, but no interparticle porosity is visible in thin section.

Below 7,000 feet, oolites decrease in abundance and the micritic limestone persists to 8,420 feet. The limestone is white to medium gray, slightly microsucrosic, unconsolidated to well consolidated, and platy to blocky in texture. This platform limestone was deposited in an inner shelf environment.

From 8,420 to 12,050 feet, the section has interbedded lithologies including light- to medium-gray to reddish-brown,

moderately indurated, calcareous, moderately fissile shale interbedded with light-medium-gray to reddish-brown, moderately hard, very calcareous siltstone, grading to sandy siltstone. The sandstone is white to light gray, fine to medium grained, subrounded to subangular, well sorted, calcareous, and porous, and is interbedded with white to light-brown, microcrystalline, hard, oolitic limestone and light- to dark-gray, moderately hard, calcareous shale with traces of coal, pyrite, glauconite, and mica. This interval was deposited in an inner shelf environment with nonmarine deltaic depositional influxes. The age is Late to Early Jurassic.

The section between 12,050 and total depth, 20,000 feet, consists of a brown, reddish-brown, and gray, moderately hard to very dense, fine cryptocrystalline limestone. This limestone has occasional black stylolitic bands and abundant euhedral calcite crystals. At some depths, oolitic limestone with sparry calcite cement is predominant. The oolites have little interpartical or intrapartical porosity and are filled with quartz or calcite and are associated with small amounts of grainstones and packstones. This interval is also slightly fossiliferous. Dolomite and anhydrite replacement increases with depth. Some of the limestone also has a chalky appearance. Minor gray to red shale and siltstone interbeds also occur. The environment of deposition is primarily a restricted marine environment with some shallow marine pulses. The age of the sediments is Early Jurassic to Late Triassic.

POTENTIAL RESERVOIR ROCKS

Analyses of rock cuttings and core data indicate that the best reservoir characteristics are associated with sandstones above 6,200 feet (see the **Formation Evaluation** chapter of this report). Average porosity ranges between 21 to 35 percent based on log analysis, but rocks at these depths are thermally immature. Sandstones of this interval are calcite cemented. From 6,200 to 12,000 feet, reservoir potential is intermediate with porosities ranging from 10 and 23 percent, according to log analysis. Calcareous silty sandstones and shales are interbedded with carbonates and are compacted and well cemented. These sediments are marginally mature to mature. Except for a 16-foot interval at 16,658 feet, the remaining rocks to total depth have poor reservoir potential. These rocks are primarily dense, tight micritic limestones with porosities of zero to 5 percent, based on log analysis. Sediments in this lowest zone are mature to probably overly mature (productive of dry gas).

The bottomhole assembly became stuck and circulation was lost at 16,521 feet because of a suspected washout. The well bore was sidetracked and a 30-foot core was taken at the level of the washout in an attempt to determine its cause. A show of gas was recorded from the supposed washout zone, which is also near the top of a possible reef, based on seismic interpretation. However, the core did not show evidence of visible porosity, nor did the “mud” log record a gas show in the sidetrack. Thus, the “washout/gas show” interval does not appear to be a petroleum reservoir with lateral extent.

BIOSTRATIGRAPHY

Taken and adapted from W. E. Steinkraus, H. L. Cousminer, and C. E. Fry, MMS internal report

The biostratigraphic and paleoenvironmental interpretations of the Mobil LC Block 312 No. 1 well are based on dinoflagellates, spores, pollen, foraminifera, and calcareous nannofossils from well cuttings samples. This report includes the results of three separate investigations by the paleontological staff of the Atlantic OCS office of the MMS. Palynological studies were made from 216 slides prepared from composite 90-foot samples extending from 540 to 19,990 feet. Foraminiferal analyses were based on 146 samples at 30-foot intervals collected between 540 and 4,920 feet. Nannofossil studies were made from 223 slides representing 30-foot intervals between 540 feet and 7,230 feet. The section contains nine recognizable unconformities. Biostratigraphic control is not adequate to determine additional hiatuses.

Two factors limit the reliability of the paleontologic data. (1) Analyses are made from drill cuttings, which are often heavily contaminated by cavings from higher in the drill hole. For this reason, only "tops" or the uppermost (last) appearances of species, are used. (2) Reworked, older fossil assemblages and individual specimens are commonly reincorporated in detrital sedimentary rocks. These fossils must be recognized so that intervals are not dated older than they really are. In addition, in U. S. Offshore Atlantic wells, biostratigraphic control is poor in pre-Late Jurassic strata. Calcareous nannofossils

and foraminifera are rare to nonexistent. Palynomorphs are more common, but their biostratigraphic distribution is not fully documented with reference to the European type-stage localities.

This investigation relies on the Jurassic palynostratigraphy of offshore eastern Canada (Bujak and Williams, 1977) because many of their palynomorph marker species are also present in the U. S. offshore Atlantic subsurface. Although the European stage equivalence of many species is not fully resolved, several species have recently been documented in European type sections (Woollam and Riding, 1983; Riding, 1984; Davies, 1985).

CENOZOIC

The Cenozoic section was dated from planktonic foraminifera. No samples above 540 feet were available. The interval examined between 540 and 630 feet contained no age-diagnostic microfossils, and was deposited in a littoral to inner-shelf (zero to 50 feet) environment.

QUATERNARY/TERTIARY

Plio-Pleistocene (630 to 660 feet)

Planktonic foraminifera recovered from this interval included Globigerinoides obliquus, Globorotalia inflata, and Globorotalia praemiocenica.

Miocene (660 to 690 feet)

Globigerinoides altiapertura and G. diminutus, found at 660 feet, indicate an age no younger than Miocene. An inner-to middle-shelf (zero to 300 feet) environment of deposition is interpreted for this interval.

Oligocene (690 to 780 feet)

The highest occurrence of the planktonic species Globigerina ampliapertura indicates an early Oligocene age for this interval; however, the age range of this species does not extend to the latest Oligocene.

Eocene (780 to 1,170 feet)

The section is characterized by sparse diatom assemblages, including Actinoptychus senarius, identified at 990 feet. The top of the Eocene is determined by the highest occurrence of the foraminifera Globorotalia cerroazulensis at 780 feet. The interval between 690 and 990 feet is delineated as inner shelf, changing to middle shelf between 990 and 1,170 feet.

Paleocene (1,170 to 1,380 feet)

The occurrence of the planktonic foraminiferan Globigerina triloculinoides indicates a Paleocene age for this interval. A sparse nannoflora was observed in this section.

MESOZOIC

CRETACEOUS

Late Cretaceous

Campanian (1,380 to 1,830 feet)

No Maestrichtian section is recognized from the microfauna and flora. The top of the Campanian is based on the highest occurrence of the planktonic foraminifera Globotruncana linneiana. The nannofossil species Gartnerago obliquum is present in the sample at 1,410 feet. The upper portion of the interval (1,380 to 1,470 feet) was deposited in a shallow, inner-shelf environment, while in the 1,470 to 1,830-foot interval, middle-shelf depths are indicated.

Santonian (1,830 to 2,400 feet)

The highest occurrence of the nannofossil Marthasterites furcatus at 1,830 feet, the palynomorph Surculosphaeridium longifuratum at 2,130 feet, and the foraminifera Globotruncana renzi at 2,340 feet indicates a Santonian age for this interval. A middle-shelf environment of deposition is indicated for the upper portion of the interval (1,830 to 2,040 feet), while outer-shelf depths occur between 2,040 and 2,400 feet.

Turonian (2,400 to 2,790 feet)

The highest occurrence of the nannofossil species Corollithion achylosum and Radiolithus planus indicates a Turonian

age for this interval. The planktonic foraminifera Globotruncana helvetica recovered at 2,580 feet is restricted to the Turonian Stage. An outer-shelf environment of deposition is interpreted for the section. A rich nannofossil and foraminiferal assemblage is present in the Turonian.

Cenomanian (2,790 to 3,390 feet)

A Cenomanian age is based on the foraminifera Rotalipora greenhornensis. The nannofossil markers Corolithon kennedyi and Lithraphidites alatus were recovered at 2,820 feet. The dinocyst Litosphaeridium siphoniphorum was identified at 2,940 feet. The upper portion of this interval between 2,790 and 3,390 feet is interpreted as a middle-shelf environment of deposition.

Early Cretaceous

Albian (3,390 to 3,930 feet)

The top of the Early Cretaceous section is determined by the highest occurrence of the spore species Appendicisporites cristatus and A. problematicus. The nannofossil species Nannoconus cf. N. bucheri was identified at 3,750 feet, and Nannoconus elongatus was found lower in the section at 3,900 feet. The palynomorph assemblage, together with the Nannoconus species, indicates an inner-shelf environment of deposition.

Aptian (3,930 to 4,470 feet)

The dinocyst Cyclonephelium attadalicum, recovered from 3,930 feet, is reported to have its highest occurrence in the Early

Aptian on the Scotian Shelf. The nannofossil species Nannoconus cf. N. "ashgeloni" was recovered at 4,020 feet. The environment of deposition is interpreted as marine middle shelf from the foraminiferal and palynomorph assemblage.

Barremian (4,470 to 5,200 feet)

The highest occurrence of the dinoflagellate species Tenua anaphrissa marks the top of the interval. This species is not known to occur in post-Barremian strata. The nannofossil species Conusphaera mexicana was recovered at 4,830 feet and Micrantholithus obtusus at 4,860 feet. An outer-shelf environment of deposition is indicated throughout the section.

Hauterivian (5,280 to 6,060 feet)

The top of the stage is at 5,280 feet, based on the highest occurrence of the palynomorphs Muderongia simplex, M. staurata, and ?Trilobosporites sp. "132." A shallow inner shelf to marginal-marine environment of deposition has been determined for this interval.

Berriasian (6,060 to 6,510 feet)

The top of the Berriasian-age section is based on the highest occurrence of the spore species Trilobosporites sp. "139." According to Bebout (1981), this palynomorph does not range above the Berriasian in the mid-Atlantic area. A marginal-marine environment of deposition is indicated throughout this interval.

The Berriasian nannofossil index species Polycostella senaria was found below this interval (see below).

JURASSIC

Late Jurassic

Tithonian (6,510 to 6,960 feet)

The upper limit of the Jurassic is interpreted on the basis of the highest occurrence of the dinocyst Ctenidodinium panneum and a mineralized zone immediately above the marker. The species is present at 6,600 feet and also at 7,140 feet. The environment of deposition ranges upward from marginal marine to shallow, inner-shelf conditions.

The Berriasian and Tithonian nannofossil species appear somewhat lower in the section than the corresponding palynomorphs. The Berriasian nannofossil Polycostella senaria has its highest occurrence at 6,930 feet. The Tithonian species Hexalithus noelae was recovered from 7,230 feet. The Berriasian-Tithonian species Polycostella beckmani is present in the sample at 7,290 feet.

The lower occurrence of the nannofossil tops in the Berriasian-Tithonian interval, as compared with the palynomorph markers, may represent a repeated section, reworking of the palynomorphs, or the anomaly may indicate faulting in the area.

Kimmeridgian (6,960 to 7,500 feet)

The Kimmeridgian is marked by many dinoflagellate species including Gonyaulacysta longicornis.

Oxfordian (7,500 to 7,860 feet)

The top of this stage is placed at 7,500 feet, based on the highest occurrence of the palynomorph Adnatosphaeridium aemulum. The nannofossil species Stephanolithion bigoti was recovered at 7,650 feet. The Kimmeridgian-Oxfordian section (6,960 to 7,860 feet) was deposited under fluctuating marginal marine to inner-shelf environments of deposition.

Middle Jurassic

Callovian (7,860 to 8,670 feet)

At 7,860 feet, the dinocyst species Gonyaulacysta aldorfensis marks the top of the Callovian. Ctenidodinium continuum, Stephanelytron scarburghense, and Valensiella ovulum were recovered at 7,950 to 8,040 feet. All four of these species do not range above the Callovian on the Scotian Shelf-Grand Banks.

Bathonian (8,670 to 9,930 feet)

The top of the Bathonian is indicated by the highest occurrence of the dinocyst Gonyaulacysta filapicata at 8,670 feet. The dinocyst Ctenidodinium pachydermum also occurs in this interval. Both of these species do not range above the Bathonian on the Scotian Shelf-Grand Banks.

Bajocian (9,930 to 10,470 feet)

The dinocyst Mendicodinium reticulatum occurs at 9,930 feet. It does not range above the Bajocian on the Scotian Shelf-Grand Banks. In addition, the dinocyst species Gonyaulacysta filapicata,

Ctenididium pachydermum, and C. tenellum continue to the bottom of this interval. These species have Bajocian-Bathonian ranges on the Scotian Shelf-Grand Banks.

The Kimmeridgian-Bajocian section (6,960 to 10,470 feet) was deposited under fluctuating marginal marine to inner-shelf environments of deposition.

Undated exinitic interval (10,470 to 11,190 feet)

This interval is marginally marine, indicated by abundant terrestrial plant detritus and rare foraminiferal linings, with no diagnostic palynomorph species. The interval 11,010 to 11,190 feet is highly oxidized and residual detritus indicates probable regression and erosion. No evidence exists of either Aalenian or Toarcian sediments, indicating that an unconformity separates Bajocian from Early Jurassic sediments.

Early Jurassic

Early Pliensbachian (11,190 to 11,910 feet)

The spore Kraeuselisporites reissingeri has its highest occurrence in this interval. The species has a known range of Rhaetian to Early Pliensbachian. It occurs no higher than Early Pliensbachian in the Scotian Shelf-Grand Banks region. The abundance of terrestrial detritus and rare foraminiferal linings indicate a marginal-marine environment of deposition.

Early Sinemurian-Late Hettangian (11,910 to 12,630 feet)

This entire interval is marginal marine and contains varied monosulcate pollen species including Cycadopites subgranulosus and other laevigate, granulate, and verrucate species of Cycadopsites, which are characteristic of the Late Hettangian-Early Sinemurian in the Scotian Shelf-Grand Banks region.

The dinocyst species Dopcodinium priscum has its highest occurrence at 12,090 feet, but becomes abundant at 12,450 feet. Gliscopollis (Corollina) meyeriana also has its highest occurrence at 12,090 feet, but first becomes abundant at 12,630 feet (top of its peak zone). D. priscum is long ranging (Rhaetian-Early Bathonian); however, G. meyeriana is no younger than Lower Pliensbachian on the Scotian Shelf-Grand Banks. A marginal-marine environment of deposition is interpreted for this interval.

Early Hettangian (12,630 to 12,990 feet)

Cycadopites spp. continue in abundance (in part due to cavings?); however, Gliscopollis (Corollina) meyeriana becomes abundant at 12,630 feet and the highest occurrence of the dinocyst genus Rhaetogonyaulax is at this depth. The top range of Rhaetogonyaulax species is given in the literature (Dorhofer and Davies, 1980) as Early Hettangian. Similarly, the highest occurrence of the Corollina meyeriana peak zone on the Scotian Shelf-Grand Banks is Early Hettangian.

This interval between 12,450 and 12,990 feet has been interpreted as an distal-deltaic environment.

TRIASSIC

Late Triassic

Rhaetian-Norian (12,990 to 14,520 feet)

Dinocyst species that have been previously described only from the Rhaeto-Norian of Arctic Canada first occur at 12,990 feet. These include Hebecysta brevicornuata, Noricysta fimbriata, N. varvallata, Sverdrupiella mutabilis, and the longer ranging Rhaetogonyaulax spp.

Accompanying the Late Triassic dinocysts are spores characteristic of Rhaeto-Norian palynoflorules including: Carnisporites anteriscus, C. leviornatus, Granuloperculatipollis rudis, Kyrtomisorites laevigatus, Leptolepidites

argenteaformis, Porcellispora longdonensis, Tsugapollenites pseudomassulae, and abundant Gliscopollis (Corollina) meyeriana.

In the Scotian Shelf-Grand Banks region, the base of the G. meyeriana peak zone occurs in sediments of Rhaetian age. The abundance of this species, in addition to the other characteristic Rhaeto-Norian dinocysts, spores, and pollen that are present in abundance to 14,420 feet, support a Late Triassic age for this interval. The environment of deposition is interpreted as marine shelf.

Barren Interval (14,520 to 19,990 feet)

All palynology slides were examined to the deepest sample (19,990 feet). These samples consist of tissue scraps and overmature inertinitic detritus but no identifiable microfossils.

FORMATION EVALUATION

Taken and adapted from R. R. Nichols, MMS internal report

Schlumberger Ltd. ran the following geophysical “electric” logs in the Mobil LC Block 312 No. 1 well to provide

information for stratigraphic correlation and for evaluation of formation fluids, porosity, and lithology:

Table 4. Well logs

Log Type	Depth Interval below KB (feet)
DISFL/Sonic (dual induction spherically focused log/sonic)	551-19,990
DLL (dual laterolog)	12,942-19,990
CNL/FDC (compensated neutron log/compensated formation density)	1,292-19,990
HDT (high resolution dipmeter)	12,942-19,990
synthetic seismogram	1,200-18,400
wellsite seismic survey	17,100-18,524
seismic calibration log (adjusted continuous velocity log)	19,190-19,990

Exploration Logging, Inc. provided a formation evaluation “mud” log, which included a rate of penetration curve, sample description, and graphic presentation of any hydrocarbon shows encountered (551 to 19,990 feet). In addition, a pressure evaluation log (600 to 19,990 feet), a drilling data pressure log (550 to 19,990 feet), a temperature log (551 to 19,990 feet), and a chlorides log (1,292 to 19,990 feet) were provided by Exploration Logging. Mobil’s final well report and daily drilling reports give the measured TD as 20,000 feet.

The electric logs, together with the mud log and other available data, were analyzed in detail to determine the thickness of potential reservoirs, average porosities and feet of hydrocarbon present. Reservoir rocks with porosities less than 5 percent were disregarded. A combination of logs was used in the analysis, but a detailed lithologic and reservoir property determination from samples, conventional cores, and sidewall cores, in addition to full consideration of any test results, is necessary to substantiate the following estimates (table 5):

Table 5. Well log interpretation summary

Epoch	Depth Interval (feet)	Potential Reservoir** (feet)	Ave ϕ	SW %	Feet of Hydrocarbon
E K	3,564-3,574	10	31	NC*	NC*
	3,669-3,716	47	35		
	4,150-4,158	8	32		
	4,245-4,255	10	31		
	4,784-4,792	8	26		
	4,805-4,825	16	28		
	5,005-5,012	7	25		
	5,015-5,020	5	34		
	5,292-5,325	33	26		
	5,476-5,497	21	21		
	5,585-5,609	24	22		
	5,933-5,947	14	31		
	5,993-6,018	20	29		
	6,124-6,146	22	28		
	6,442-6,452	10	27		
	L-M Jr	6,750-6,766	16	26	
8,880-8,894		12	12		
9,032-9,045		13	18		
9,052-9,066		14	17		
9,257-9,278		21	16		
9,362-9,385		23	17		
9,514-9,535		21	15		
10,028-10,038		10	21		
10,062-10,082		16	15		
10,376-10,395	19	12			
Indet	16,658-16,672	14	5		

* Not calculated

** Generally in beds > 10 feet thick and ϕ > 5%

The electric logs were of acceptable quality. However, the medium induction curve was in error from 13,500 to 18,410 feet. The SP is cyclic and very noisy from 4,920 to 19,975 feet and the caliper malfunctioned from 15,850 to 16,100 feet. In addition, the gamma ray curve is not available for the interval 16,300 to 17,100 feet. Tool rotation for the dipmeter is

excessive from 15,800 to 16,300 feet, 17,750 to 18,400 feet, and 19,500 to 19,990 feet.

SIDEWALL CORE SUMMARY

Sidewall cores were taken from 8,090 to 12,108 feet and are summarized in table 6.

Table 6. Sidewall core summary

Depth Interval (Feet)	Lithology	Porosity Range (%)	Permeability Range (md)
8,090-12,108	Shale	NC*	NC*

*Not calculated

One conventional core was taken in this well. A detailed petrologic examination

was performed and the results are as follows:

Table 7. Conventional core summary

Core No.	Depth Interval (Feet)	Lithology	Porosity Range (%)	Permeability Range (md)
1	15,810-15,840	LS	NC*	NC*

*Not calculated

The bottom 23 feet of core are described as an interbedded sequence of micrite and calcarenite with most fractures sealed by calcite, dolomite, or both. The upper seven feet of core are described as calcarenite made up of oolites and bioclastic grains, tightly cemented.

This assessment compares favorably with the porosity derived from the Sonic, Density, and Neutron logs (0 to 2 percent).

DIPMETER

Results of the HDT survey were recorded on a dipmeter arrow plot from 12,942 to 19,990 feet. No definite structural anomalies were recognized on the arrow plot. However, a possible unconformity can be observed at 13,135 feet. The northwest dip of 3⁰ to 4⁰ continues down to 16,200 feet, where the dip becomes west to southwest at 4⁰ to 5⁰. From 16,550 to 18,050 feet, the dips are quite scattered. Below 18,050 feet, the dip direction returns to the southwest and from

19,200 to 19,990 feet, the dip is quite uniform at 4⁰ to 5⁰ south-southwest.

SIGNIFICANT SHOWS

As shown in table 8, there were no shows of hydrocarbon encountered in this well that were judged to be significant.

A normal pressure gradient (approximately 9.0 ppg. EQMW) was encountered to a depth of 14,740 feet. From 14,750 to 15,480 feet, the d_{xc} values indicated a gradient of 0.525 psi/ft. (10.1 ppg EQMW). From 15,480 to 16,200 feet the

d_{xc} values indicated a pore pressure increase to 0.681 psi/ft. (13.1 ppg EQMW). Flowline temperature and cuttings volume both increased. Mud weight was increased to 12.0 ppg at 16,518 feet, but at a depth of 16,521 feet, the bottomhole assembly became stuck and circulation was lost. On the third attempt, the hole was sidetracked at 15,079 feet. Mud weights were increased from 14 to 14.5 ppg for the remainder of the hole.

No flow tests of any zone were taken in this well

GEOHERMAL GRADIENT

Figure 8 shows bottomhole temperatures for seven logging runs in the Mobil LC Block 312 No. 1 well plotted against depth. A temperature of 60 °F is assumed at the seafloor at an indicated depth of 348 feet (259-foot water depth plus 89-foot kelly bushing elevation). Shown also is a

straight-line graph between the seafloor and total-depth temperatures in order to represent an overall geothermal gradient for the well, which is 1.27 °F/100 ft. Calculated geothermal gradients for all Georges Bank wells range from 1.06 to 1.40 °F/100 ft.

PETROLEUM GEOCHEMISTRY

Taken and adapted from C. E. Fry and H. L. Cousminer, MMS internal report

Kerogen types and thermal rank were determined by microscopic examination of kerogen slides and palynology slides made from drill cutting samples from the Mobil LC Block 312 No. 1 well. Total organic carbon and vitrinite reflectance data are from a geochemical report done by Core Laboratories, Inc. (Core Lab), for Mobil Exploration and Producing Services, Inc. (Mobil), and from analyses by the Branch of Oil and Gas Resources, U. S. Geological Survey.

In this report, organic material is classified as one of four major kerogen types: algal-amorphous, organic material of marine origin, either recognizable algae or the unstructured remains of algal material; herbaceous, leafy portions of plants, including spores and pollen; woody, plant detritus with a lignified, ribbed structure; coaly, black, opaque material thought to be chemically inert. Visual estimates are made for the percentage of each type, relative to the total abundance of kerogen, contained in each of the slides. Algal material is generally considered the best source for oil; more structured, terrestrial kerogen is primarily a gas source.

Thermal maturity of the organic material is estimated by comparing the color of various palynomorphs contained in the kerogen slides to the thermal alteration index (TAI) scale taken from Jones and Edison (1978). Measuring the exact amount of light reflected from a piece of vitrinite (a humic coal maceral commonly disseminated in sedimentary rocks)

provides additional maturation data that can be compared to the TAI determinations. Relationships among various maturity indicators are shown in figure 9.

Kerogen type and thermal alteration rank can be used with total organic carbon abundances to evaluate whether sediments in a well are prospective as petroleum source rocks.

KEROGEN TYPE

Algal kerogen is recognizable in the Mobil LC Block 312 No. 1 well from 900 to 11,400 feet (figure 10). Significant peaks of this material occur at five intervals: 2,670 to 2,760 feet (30 percent algal kerogen), 3,300 to 3,390 feet (15 percent algal kerogen), 3,750 to 4,290 feet (15 to 25 percent algal kerogen), 5,010 to 6,060 feet (20 to 30 percent algal kerogen), and 7,320 to 9,300 feet (5 to 25 percent algal kerogen). However, even where these peaks of algal material occur, the samples contain at least 50 percent woody and coaly kerogen. Below 9,300 feet, the samples are dominated by terrestrial kerogens, (herbaceous, woody, and coaly), which maintain fairly constant abundances, relative to one another, at all depths sampled.

MATURITY

Judging thermal maturity from drill cuttings must be done with great care to ensure that the material being analyzed is indigenous to the level sampled. Caved or reworked material will both give false indications of maturity. Oxidation caused by a high energy environment of deposition can also alter the appearance of organic material.

Core Lab's vitrinite reflectance data indicate a reading of 0.6 R_O at approximately 8,400 feet. 0.6 R_O is the level representing the onset of oil generation according to Jones and Edison (1978). A R_O value of 0.9 indicates peak maturity at approximately 11,000 feet. This is the highest value obtained by the Core Lab analysis; however, samples below 12,810 feet were not tested.

The visual estimation of thermal maturity done by MMS, using palynomorph color, does not agree with the vitrinite reflectance data. In as many cases as possible, the palynomorphs used for visual color determination were fossil markers to ensure the material analyzed was indigenous. The TAI analysis indicates

that the oil window begins at 10,560 feet, and peak generation occurs at 12,990 feet. The interval between 13,000 feet and 15,000 feet contains too much oxidized material for reliable analysis.

TOTAL ORGANIC CARBON

Sedimentary organic material must be present in sufficient quantity for rocks to be considered to be potential hydrocarbon sources. In general, shales in which the total organic carbon (TOC) is less than 0.5 percent are not considered prospective sources for hydrocarbon generation. TOC measurements were taken by Core Lab for samples from the Mobil LC Block 312 No. 1 well at 30-foot intervals beginning at 540 feet and ending at 18,530 feet. Higher concentrations of organic material occur from 1,170 to 1,320 feet (1.08 to 1.36 percent), 2,040 to 2,850 feet (0.52 to 2.12 percent), 3,330 to 3,450 feet (0.84 to 1.59 percent), and especially from 6,090 to 6,180 feet (1.05 to 2.70 percent). The interval from 8,040 to 11,310 feet is marginally prospective with TOC values between 0.4 and 0.69 percent. Below 11,310 feet, TOC values gradually decrease to 15,490 feet, where they stabilize at a level below 0.1 percent.

Table 9. Total organic carbon analysis
U. S. Geological Survey, Branch of Oil and Gas Resources

Series	Depth Interval (feet)	% TOC
UK	990-1,020	1.09
	2,040-2,070	1.53
	2,850-2,880	0.58
	3,000-3,030	0.24
LK	3,510-3,540	0.53

continued

Table 9. Total organic carbon analysis--continued

Series	Depth Interval (feet)	% TOC
LK	3,990-4,020	0.40
	4,530-4,560	0.73
	5,010-5,040	0.19
	5,490-5,520	0.31
	6,060-6,090	2.64
UJ	6,510-6,540	0.63
	6,990-7,020	0.48
	7,500-7,530	0.21
MJ	8,010-8,040	0.43
	8,490-8,520	0.65
	8,940-8,970	0.78
	9,510-9,540	0.73
	9,990-10,020	1.03
Indeterminate	10,500-10,530	0.57
	11,010-11,040	0.32
LJ	11,490-11,520	0.23
	12,000-12,030	0.29
	12,390-12,420	0.20
	12,900-12,930	0.38
Tr	13,500-13,510	0.11
	14,000-14,010	0.12
	14,500-14,510	0.10
Indeterminate (barren)	15,000-15,010	0.11
	15,500-15,510	0.04
	16,000-16,010	0.03
	16,500-16,510	0.03

Sidetrack

Series	Depth Interval (feet)	% TOC
Indeterminate (barren)	15,000-15,010	3.08*
	15,500-15,510	0.16
	16,000-16,010	0.28
	16,500-16,510	0.26
	17,000-17,010	0.03

continued

Table 9. TOC analysis, sidetrack--continued

Series	Depth Interval (feet)	% TOC
Indeterminate (barren)	17,500-17,510	0.09
	18,000-18,010	0.20
	18,500-18,510	0.36
	19,000-19,010	0.30
	19,500-19,510	0.13
	19,990-20,000	0.20

* Mud additive lignite compound is about 80 percent of this sample.

The branch of Oil and Gas Resources of the U. S. Geological Survey (USGS) analyzed 42 cuttings samples from the Mobil LC Block 312 No. 1 well for total organic carbon, and the results are presented in Table 9 and in figure 10. Where sample intervals coincide, the Mobil and USGS TOC data are in general agreement with the USGS reporting somewhat lower organic richness, overall.

BURIAL HISTORY

A time-temperature-burial diagram is shown in Figure 11 for the Mobil LC Block 312 No. 1 well. This diagram is constructed from the geological time scale of Van Hinte (1976a, 1976b) and MMS paleontologic age determinations (Biostratigraphy section). Such diagrams are similar for all Georges Bank wells for post-rift-stage burial. Basinal subsidence is greatest in the Middle Jurassic, decreases through the Late Jurassic and Early Cretaceous, and remains low through the Late Cretaceous and Cenozoic. Rift-stage burial profiles for these wells appear to be less consistent, owing to

sparse Early Jurassic and older marker fossils.

CONCLUSION

Thermal maturity and organic carbon content limit which sediments can be considered prospective source beds in the Mobil LC Block 312 No. 1 well. Samples above 10,560 feet are not thermally mature for hydrocarbon generation. Samples below 11,310 feet do not contain sufficient organic material to be prospective as a hydrocarbon source. Maturity ranges from borderline to peak generation in the interval 10,560 feet to 12,990 feet, but TOC values are moderately prospective from only 10,560 to 11,310 feet. Terrestrial kerogen, which is conducive for gas generation, dominates this most-favorable interval.

These data and this report consider only the hydrocarbon source potential of rocks penetrated by the well. Deeper source beds are not addressed but are important in assessing the petroleum potential of Georges Bank Basin.

COMPANY-SUBMITTED DATA

Data and reports were submitted by Mobil Exploration and Producing Inc. to MMS when the Mobil Lydonia Canyon (LC) Block 312 No. 1 well was drilled, as required by Federal regulations and lease stipulations. Items of general geological, geophysical and engineering usefulness are listed below. Items not listed include routine required submittals, such as the Exploration Plan, Application for Permit to Drill, and daily drilling reports, and detailed operations information, such as drilling pressure and temperature data logs. Well "electric" logs are listed in the **Formation Evaluation** chapter. Listed and unlisted company reports and data are available through the Public Information Unit, Minerals Management Service, Gulf

of Mexico OCS Region, 1201 Elmwood Park Boulevard, New Orleans, Louisiana 70123-2394; telephone (504)736-2519 or 1-800-200-GULF, FAX (504)736-2620. Well logs are available on microfilm from the National Geophysical Data Center, 325 Broadway Street, Boulder CO 80303-3337, attn. Ms Robin Warnken; telephone (303) 497-6338, FAX (303) 497-6513; e-mail rwarnken@NGDC.NOAA.GOV.

At a later date, additional original technical data, including well logs, will be added to the compact disk (CD) version of the Georges Bank well reports. The CD will be available from the Gulf of Mexico OCS Region Public Information Unit.

SELECTED COMPANY-SUBMITTED DATA

Final well report (summaries of data and interpretations or: Drilling and engineering, Formation pressure, Geology and shows, Evaluation and testing), Exploration Logging of U.S.A., Inc. (Exlog), undated.

Physical formation ("mud") log, EXLOG, undated.

Biostratigraphic and organic geochemical studies (paleontology, biostratigraphy, paleoenvironment, total organic carbon, Rock-Eval, kerogen analysis, vitrinite reflectance, thermal alteration index and interpretations of data), Mobil Exploration and Producing Services, Inc. (MEPSI), Applied Stratigraphy, Dallas, TX, 07/82.

Petrology of core from 15,810-840 feet in Mobil Narragansett 12-1, offshore, East Coast, U.S.A., MEPSI, Applied Stratigraphy, Dallas, TX, 05/82.

Total organic carbon and Rock-Eval pyrolysis (406 samples from 540 to 12,990 feet), Core Laboratories (Corelab), Inc., Dallas TX, 04/14/82.

Total organic carbon (114 samples from 13,020 to 16,460 feet), Corelab, Dallas TX, 05/12/82.

Total organic carbon and Rock-Eval pyrolysis (96 samples from 15,640 to 18,530 feet), Corelab, Dallas, TX, 06/11/82.

SELECTED REFERENCES

This list is compiled from published and unpublished Minerals Management Service and USGS Conservation Division reports on Georges Bank wells. Not all of the references could be located and verified.

- Albrecht, P., 1970, Etude de constituents organiques des series sedimentaries de Logbaba et Messel. Transformations deagenetiques: Universite de Strasbourg, Memoires du Service de la Charge Geologique d'Alsac et de Lorraine, no. 32, 119 p.
- Amato, R.V. and J.W. Bebout, 1978, Geological and Operational Summary, COST No. GE-1 Well, Southeast Georgia Embayment Area, South Atlantic OCS: U. S. Geological Survey Open-File Report 78-668, 122 p.
- Amato, R. V. and J. W. Bebout (eds.), 1980, Geologic and Operational Summary, COST No. G-1 Well, Georges Bank Area, North Atlantic OCS: U. S. Geological Survey Open-File Report 80-268, 112 p.
- Amato, R.V., and E.K. Simonis (eds.), 1979, Geologic and Operational Summary, COST No. B-3 Well, Baltimore Canyon Trough Area, Mid-Atlantic OCS: U.S. Geological Survey Open-File Report 79-1159, 118 p.
- Amato, R.V. and E.K. Simonis,(eds.), 1980, Geologic and Operational Summary, COST No. G-2 Well, Georges Bank Area, North Atlantic OCS: U. S. Geological Survey Open-File Report 80-269, 116 p.
- BBN-Geomarine Services Co., 1975, COST wellsite G-1, Georges Bank, engineering geology interpretation of high-resolution geophysical data: Houston, Texas, 11 p.
- Ballard, R. D. and E. Uchupi, 1975, Triassic rift structure in Gulf of Maine: American Association of Petroleum Geologists Bulletin, v. 59, no. 7, p. 1041-1072.
- Bayliss, G. S., 1980, Source-rock evaluation reference manual: Houston, Texas, Geochem Laboratories, Inc., 80 p.
- Bebout, J. W., 1980, Observed stratigraphic distribution of spores, pollen, and *incertae sedis* palynomorphs in the Tertiary section of the COST No. B-2 well, Baltimore Canyon, Atlantic Outer Continental Shelf: Palynology, v. 4, p. 181-196.
- Bebout, J. W., 1981, An informal palynologic zonation for the Cretaceous System of the United States Mid-Atlantic (Baltimore Canyon area) Outer Continental Shelf: Palynology, v. 5, p. 159-194.
- Berggren, W.A., D.V. Kent, C.C. Swisher III, and M.P. Aubry, 1995, A revised Cenozoic geochronology and chronostratigraphy; in Geochronology Time Scales and Global Stratigraphic Correlation, SEPM Special Publication no. 54, p. 129-212.
- Bhat, H., N. J. McMillan, J. Aubert, B. Porthault, and M. Surin, 1975, North American and African drift--the record in Mesozoic coastal plain rocks, Nova Scotia and Morocco, in Yorath, C. J., E. R. Parker, and D. J. Glass, (eds.), Canada's Continental Margins and Offshore Petroleum Exploration: Canadian Society of Petroleum Geologists Memoir 4, p. 375-389.

- Brideau, W. W. and W. C. Elsick, (eds.), 1979, Contributions of stratigraphic palynology (v. 2), Mesozoic Palynology: American Association of Stratigraphic Palynologists Contributions Series No. 4.
- Bronnimann, P., 1955, Microfossils *incertae sedis* from the Upper Jurassic and Lower Cretaceous of Cuba: Micropaleontology, v. 1, pp. 28, 2 pl., 10 text.
- Bujak, J. P., M. S. Barss, and G. L. Williams, 1977, Offshore east Canada's organic type and color and hydrocarbon potential: Oil and Gas Journal, v. 75, no. 15, p. 96-100.
- Bujak, J. P. and M. J. Fisher, 1976, Dinoflagellate cysts from the Upper Triassic of Arctic Canada: Micropaleontology, v. 22, p. 44-70, 9 pls.
- Bujak, J. P. and G. L. Williams, 1977, Jurassic palynostratigraphy of offshore eastern Canada, *in* Swain, F. M., (ed.), Stratigraphic Micropaleontology of Atlantic Basin and Borderlands: New York, Elsevier Scientific Publishing Co., p. 321-339.
- Bukry, D., 1969, Upper Cretaceous coccoliths from Texas and Europe: University of Kansas Paleontological Contributions, Art. 5 (Protista 2), p. 1-9, 50 pl., 1 text.
- Burk, C. A. and C. L. Drake, (eds.), 1974, Geology of Continental Margins: New York, Springer-Verlag, 1,009 p.
- Burke, K., 1975, Atlantic evaporites formed by evaporation of water spilled from Pacific, Tethyan, and southern oceans: Geology, v. 3, no. 11, p. 613-616.
- Cepek, P. and W. W. Hay, 1970, Zonation of the Upper Cretaceous using calcareous nannoplankton: Palaontologische Abhandlungen, Abteilung B Paläobotanik, Band III, Heft 3/4, p. 333-340.
- Cita, M. B. and S. Gartner, 1971, Deep Sea Upper Cretaceous from the western North Atlantic: *in* Proceedings II International Planktonic Conference, Roma, 1970: Rome, Edizioni Tecnoscienza, v. 1, p. 287-319.
- Clarke, R. F. A. and J. P. Verdier, 1967, An investigation of microplankton assemblages from the chalk of the Isle of Wight, England: Verhandelingen der Koninklijke Nederlandse Akademie van Wetenschappen, Afdeling Natuurkunde, and Eerste Reeks, 24, p. 1-96.
- Claypool, G. E., C. M. Lubeck, J. P. Baysinger, and T. G. Ging, 1977, Organic geochemistry, *in* Scholle, P. A., (ed.), Geological studies on the COST No. B-2 well, U. S. Mid-Atlantic Outer Continental Shelf area: U. S. Geological Survey Circular 750, p. 46-59.
- Connan, J. 1974, Time-temperature relation in oil genesis: American Association of Petroleum Geologists Bulletin, v. 58, no. 12, p. 2516-2521.
- Core Laboratories, Inc., 1976, Core studies, COST Atlantic well No. G-1, Georges Bank, Offshore Atlantic Ocean: Dallas, Texas, 153 p.
- Core Laboratories, Inc., 1977a, Core studies, COST Atlantic well No. G-2, Georges Bank, Offshore Atlantic Ocean: Dallas, Texas, 298 p.
- Core Laboratories, Inc., 1977b, Geochemical service report, COST G-2 Atlantic well, Georges Bank, offshore Massachusetts, U. S. A.: Dallas, Texas, 147 p.

- Council on Environmental Quality, 1974, OCS oil and gas--An environmental assessment--A report to the President by the Council on Environmental Quality: Washington, D. C. (U. S. Government Printing Office), Stock No. 4000-00322, v. 1, 214 p.
- Cousminer, H. L., 1984, Canadian dinoflagellate zones (Middle Jurassic to Middle Eocene) in Georges Bank Basin (abstract): Proceedings of the American Association of Stratigraphic Palynologists, Arlington, Virginia, v. 9, p. 238.
- Cousminer, H. L., W. E. Steinkraus, and C. E. Fry, 1982, Biostratigraphy and thermal maturation profile, Exxon 133 No. 1 (OCS-A-0170) well section: Unpublished Report, Minerals Management Service.
- Cousminer, H. L., W. E. Steinkraus, and R. E. Hall, 1984, Biostratigraphic restudy documents Triassic/Jurassic section in Georges Bank COST G-2 well (abstract): Proceedings of the American Association of Petroleum Geologists, Annual Meeting, San Antonio, Texas, v. 68, no. 4, p. 466.
- Davey, R. J., 1979, The stratigraphic distribution of dinocysts in the Portlandian (latest Jurassic) to Barremian (Early Cretaceous) of northwest Europe: American Association of Stratigraphic Palynologists Contributions, Series No. 5B, p. 49-81.
- Davey, R. J. and J. P. Verdier, 1974, Dinoflagellate cysts from the Aptian type sections at Gargas and La Bedoule, France: Paleontology, v. 17, pt. 3, p. 623-653.
- Davies, E. H., 1985, The miospore and dinoflagellate cyst oppeI-zonation of the Lias of Portugal: Palynology, v. 9, p. 105-132.
- Dorhofer, G. and E. H. Davies, 1980, Evolution of archeopyle and tabulation in Rhaetogonyaulacian dinoflagellate cysts: Royal Ontario Museum, Life Sciences Miscellaneous Publications, p. 1-91, fig. 1-40.
- Dow, W. G., 1974, Application of oil-correlation and source-rock data to exploration in Williston Basin: American Association of Petroleum Geologists Bulletin, v. 58, no. 7, p. 1253-1262.
- Dow, W. G., 1977, Kerogen studies and geological interpretations: Journal of Geochemical Exploration, v. 7, p. 79-99.
- Drake, C. L., J. I. Ewing, and H. Stockard, 1968, The continental margin of the eastern United States: Canadian Journal of Earth Science, v. 5, no. 4, p. 993-1010.
- Drake, C. L., M. Ewing, and G. H. Sutton, 1959, Continental margins and geosynclines--The east coast of North America north of Cape Hatteras, *in* Aherns, L. H., and others, (eds.), Physics and Chemistry of the Earth, v. 3: New York, Pergamon, p. 110-198.
- Eliuk, L. S., 1978, the Abenaki Formation, Nova Scotia, Canada--A depositional and diagenetic model for a Mesozoic carbonate platform: Bulletin of Canadian Petroleum Geology, v. 26, no. 4, p. 424-514.
- Emery, K. O. and E. Uchipi, 1972, Western North Atlantic Ocean--Topography, rocks, structure, water, life, and sediments: American Association of Petroleum Geologists Memoir 17, 532 p.
- Evitt, W. R., (ed.), 1975, Proceedings of a forum on dinoflagellates: American Association of Stratigraphic Palynologists Contributions, Series No. 4, 76 p.

- Folger, D. W., 1978, Geologic hazards on Georges Bank--an overview: Geological Society of America Abstracts with Programs, v. 10, no. 1, p. 42.
- Fry, C. E., 1979, Geothermal gradient, *in* Amato, R. V. and E. K. Simonis (eds.), Geologic and Operational Summary, COST No. B-3 well, Baltimore Canyon Trough Area, Mid-Atlantic OCS: U. S. Geological Survey Open-File Report 79-1159, p. 64-65.
- Gartner, S., Jr., 1968, Coccoliths and related calcareous nannofossils from Upper Cretaceous deposits of Texas and Arkansas: University of Kansas Paleontological Contributions, no. 48, Protista, v. 48, Art. 1, p. 1-56.
- GeoChem Laboratories, Inc., 1976, Hydrocarbon source facies analysis, COST Atlantic G-1 well, Georges Bank, offshore Eastern United States: Houston, Texas, 10 p.
- GeoChem Laboratories, Inc., 1977, Hydrocarbon source facies analysis, COST Atlantic G-2 well, Georges Bank, offshore eastern United States: Houston, Texas, 66 p.
- Gibson, T. G., 1970, Late Mesozoic-Cenozoic tectonic aspects of the Atlantic coastal margin: Geological Society of America Bulletin, v. 81, no. 6, p. 1813-1822.
- Gitmez, G. U. and W. A. S. Sarjeant, 1972, Dinoflagellate cysts and acritarchs from the Kimmeridgian (Upper Jurassic) of England, Scotland and France: Bulletin of the British Museum of Natural History: Geology, v. 21, p. 171-257.
- Given, M. M., 1977, Mesozoic and Early Cenozoic geology of offshore Nova Scotia: Bulletin of Canadian Petroleum Geology, v. 25, p. 63-91.
- Gocht, H., 1970, Dinoflagellaten-Zysten aus dem Bathonium des erdolfeldes Aldorf (Northwest-Setuschland): Palaeontographica, Abt. B., v. 129, p. 125-165.
- Gorka, H., 1963, Coccolithophorides, Dinoflagellates, Hystrichosphaerides et microfossiles *incertae sedis* du Cretace superier de Pologne: Acta Palaeontologica Polonica, v. 8, p. 1-82.
- Gradstein, F.M., F.P.Achterberg, J.G. Ogg, J.Hardenbol, P. van Veen, and Z. Huang, 1995, A Triassic, Jurassic, and Cretaceous time scale; *in* Geochronology Time Scales and Stratigraphic Correlation, SEPM Special Publication no. 54, p. 95-126.
- Grose, P. L. and J. S. Mattson, 1977, The Argo Merchant oil spill--A preliminary scientific report: National Oceanic and Atmospheric Administration Environmental Research Laboratories, 129 p.
- Grow, J. A., R. E. Mattick, and J. S. Schlee, 1979, Multichannel seismic depth sections and interval velocities over continental shelf and upper continental slope between Cape Hatteras and Cape Cod, *in* Watkins, J. S., L. Montadert, and P. W. Dickerson, (eds.), Geological and Geophysical Investigations of Continental Margins: American Association of Petroleum Geologists Memoir 29, p. 65-83.
- Harwood, R. J., 1977, Oil and gas generation by laboratory pyrolysis of kerogen: American Association of Petroleum Geologists Bulletin, v. 61, no. 12, p. 2082-2102.
- Hill, M. E., III, 1976, Lower Cretaceous Nannofossils from Texas and Oklahoma: Paleontographica, Abteilung B, 156, Lfg. 4-6, p. 103-179.

- Hunt, J. M., 1967, The origin of petroleum in carbonate rocks: *in* G. V. Chilingar, H. S. Bissell, and R. W. Fairbridge, (eds.), Carbonate Rocks: New York, Elsevier, p. 225-251.
- Hunt, J. M., 1974, Hydrocarbon and kerogen studies, *in* C. C von der Borch and others, Initial Reports of the Deep Sea Drilling Project, v. 22: Washington, D. C., U. S. Government Printing Office, p. 673-675.
- Hunt, J. M., 1978, Characterization of bitumens and coals: American Association of Petroleum Geologists Bulletin, v. 62, no. 2, p. 301-303.
- Hunt, J. M., 1979, Petroleum Geochemistry and Geology: San Francisco, W. H. Freeman Co., p. 273-350.
- Hurtubise, D. O. and J. H. Puffer, 1985, Nepheline normative alkalic dolerite of the Georges Bank Basin, North Atlantic, part of an Early Cretaceous eastern North American alkalic province: Geological Society of America, Northeastern Section, 20th Annual Meeting, 1985, v. 17, no. 1, p. 25.
- Hurtubise, D. O., J. H. Puffer, and H. L. Cousminer, 1987, An offshore Mesozoic igneous sequence, Georges Bank Basin, North Atlantic: Geological Society of America Bulletin, v. 98, no. 4, p. 430-438.
- International Biostratigraphers, Inc., 1976, Biostratigraphy of the COST G-1 Georges Bank test: Houston, Texas, 16 p.
- International Biostratigraphers, Inc., 1977, Biostratigraphy of the COST G-2 Georges Bank test: Houston, Texas, 16 p.
- Jansa, L. F. and J. A. Wade, 1975, Geology of the continental margin off Nova Scotia and Newfoundland, *in* W. J. M van der Linden and J. A. Wade (eds.), Offshore Geology of Eastern Canada: Geological Survey of Canada Paper 74-30, v. 2, p. 51-105.
- Jansa, L. F. and J. Wiedmann, 1982, Mesozoic-Cenozoic development of the eastern North American and northwest African continental margins: a comparison, *in* V. von Rad, K. Hinz, M. Sarnthein, and E. Seibold (eds.), Geology of the Northwest African Continental Margin: Berlin, Springer-Verlag, p. 215-269.
- Jansa, L. F., G. L. Williams, J. A. Wade, and J. P. Bujak, 1978, COST B-2 well (Baltimore Canyon) and its relation to Scotian Basin (abstract): American Association of Petroleum Geologists Bulletin, v. 62, no. 3, p. 526.
- Jones, R. W. and T. A. Edison, 1978, Microscopic observations of kerogen related to geochemical parameters with emphasis on thermal maturation, *in* D. F Oltz (ed.), Geochemistry: Low Temperature Metamorphism of Kerogen and Clay Minerals: Society of Economic Paleontologists and Mineralogists, Pacific Section, Annual Meeting, Los Angeles, p. 1-12.
- Kent, D. V. and F. M. Gradstein, 1986, A Jurassic to Recent chronology, *in* P. R. Vogt and B. E. Tucholke (eds.), The Geology of North America, vol. M, The Western North Atlantic Region: Geological Society of America, p. 45-50.
- King, L. H. and B. MacLean, 1975, Geology of the Scotian Shelf and adjacent areas: Canadian Geological Survey Paper 74-23, p. 22-53.

- Kinsman, D. J. J., 1975, Rift Valley basins and sedimentary history of trailing continental margins, in A. G. Fisher and S. Judson, (eds.), *Petroleum and Global Tectonics*: Princeton, Princeton University Press, p. 83-126.
- Kjellstrom, G., 1973, Maastrichtian microplankton from the Hollviken borehole No. 1 in Scania, southern Sweden: *Sveriges Geologiska Undersokning, Afhandlingar och Uppsatser*, v. 7, p. 1-59.
- Landes, K. K. 1967, Eometamorphism and oil and gas in time and space: *American Association of Petroleum Geologists Bulletin*, v. 51, no. 6, p. 828-841.
- LaPlante, R. E., 1974, Hydrocarbon generation in Gulf Coast tertiary sediments: *American Association of Petroleum Geologists Bulletin*, v. 58, no. 7, p. 1281-1289.
- Larskaga, Ye. S. and D. V. Zhabreu, 1964, Effects of stratal temperatures and pressures on the composition of dispersed organic matter (from the example of the Mesozoic-Cenozoic deposits of the Western Ciccaspian region): *Dokl. Akad. Nauk SSSR*, v. 157, no. 4, pp. 135-139.
- Lentin, J. K. and G. L. Williams, 1981, *Fossil Dinoflagellates, Index to Genera and Species*: Bedford Institute of Oceanography Report Series B1-R-81-12, p. 1-345.
- Louis, M. C. and B. P. Tissot, 1967, Influence de la temperature et de la pression sur la formation des hydrocarbures dans les argiles a kerogen [Influence of temperature and pressure on the generation of hydrocarbons in shales containing kerogen], *in 7th World Petroleum Congress, Proceedings, (Mexico)*, v. 2: Chichester, International, John Wiley and Sons, p. 47-60.
- Lowell, J. D., G. J. Genik, T. H. Nelson, and P. M. Tucker, 1975, Petroleum and plate tectonics of the southern Red Sea, *in A. G. Fisher and S. Judson, (eds.), Petroleum and Global Tectonics*: Princeton University Press, Princeton, p. 129-153.
- McIver, N. L., 1972, Cenozoic and Mesozoic stratigraphy of the Nova Scotia shelf: *Canadian Journal of Earth Sciences*, v. 9, p. 54-70.
- MacLean, B.C., and J.A. Wade, 1992, Petroleum geology of the continental margin south of the islands of St. Pierre and Miquelon, offshore eastern Canada; *Bulletin of Canadian Petroleum Geology*, v. 40, no. 3, p. 222-253.
- Maher, J. C., 1971, *Geologic Framework and Petroleum Potential of the Atlantic Coastal Plain and Continental Shelf*: U. S. Geological Survey Professional Paper 659, 98 p.
- Martini, E., 1971, Standard Tertiary and Quaternary calcareous nannoplankton zonation *in Proceedings II International Planktonic Conference, Roma, 1970*: Rome, Edizioni Tecnoscienza, p. 739-785.
- Mattick, R. E., R. Q. Foote, N. L. Weaver, and M. S. Grim, 1974, Structural framework of United States Atlantic Outer Continental Shelf north of Cape Hatteras: *American Association of Petroleum Geologists Bulletin*, v. 58, no. 6, 1179-1190.
- Miller, R. E., H. E. Lerch, G. E. Claypool, M. A. Smith, D. K. Owings, D. T. Lignon, and S. B. Eisner, 1982, Organic geochemistry of the Georges Bank basin COST Nos. G-1 and G-2 wells, *in P. A. Scholle and C. R. Wenkam (eds.), Geological Studies of the COST Nos. G-1 and G-2 Wells, Unites States North Atlantic Outer Continental Shelf*: U. S. Geological Survey Circular 861, p. 105-142.

- Miller, R. E., R. E. Mattick, and H. E. Lerch, 1981, Petroleum geochemistry and geology of Cenozoic and Mesozoic sedimentary rocks from Georges Bank basin (abstract): American Association of Petroleum Geologists Bulletin, v. 65, no. 9, p. 1667.
- Miller, R. E., D. M. Schultz, G. E. Claypool, H. E. Lerch, D. T. Lignon, C. Gary, and D. K. Owings, 1979, Organic geochemistry, *in* , P. A. Scholle (ed.), Geological Studies of the COST GE-1 Well, United States South Atlantic Outer Continental Shelf Area: U. S. Geological Survey Circular 800, p. 74-92.
- Miller, R. E., D. M. Schultz, G. E. Claypool, M. A. Smith, H. E. Lerch, D. Ligon, D. K. Owings, and C. Gary, 1980, Organic geochemistry, *in* P.A. Scholle (ed.), Geological Studies of the COST No. B-3 Well, United States Mid-Atlantic Continental Slope Area: U. S. Geological Survey Circular 833, p. 85-104.
- Miller, R. E., D. M. Schultz, H. E. Lerch, D. T. Lignon, and P. C. Bowker, 1986, *in* Edson, G. M.(ed.), Shell Wilmington Canyon 586-1 Well, Geological and Operation Summary: Minerals Management Service, OCS Report MMS 86-0099, p. 37-44.
- Miller, R. E., D. M. Schultz, H. E. Lerch, D. T. Lignon, and P. C. Bowker, 1987, *in* Edson, G. M. (ed.), Shell Wilmington Canyon 587-1 Well, Geological and Operation Summary: Minerals Management Service, OCS Report MMS 87-0074, p. 39-46.
- Momper, J. A., 1978, Oil migration limitations suggested by geological and geochemical considerations, *in* Physical and Chemical Constraints on Petroleum Migration: American Association of Petroleum Geologists, Continuing Education Course Note Series No., 8, p. B1-B60.
- Morbey, S. J., 1975, The palynostratigraphy of the Rhaetian Stage Upper Triassic in the Kerdelbachgraben Austria: Paleontographica Abtrlung B, v. 152, p. 1-75, p. 1-19.
- Murray, G. E., 1961, Geology of the Atlantic and Gulf Coastal Provinces of North America: New York, Harper, 692 p.
- Orr, W. L., 1974, Changes in sulfur content and isotopic ratios of sulfur during petroleum maturation--study of Big Horn Basin Paleozoic oils: American Association Petroleum Geologists Bulletin, v. 58, no. 11, p. 2295-2318.
- Perry, W. J., J. P. Minard, E. G. A. Weed, E. I. Robbins, and E. C. Rhodehamel, 1975, Stratigraphy of the Atlantic continental margin of the United States north of Cape Hatteras--brief survey: American Association of Petroleum Geologists Bulletin, v. 59, no. 9, p. 1529-1548.
- Phillipi, G. T., 1957, Identification of oil-source beds by chemical means, *in* 20th International Geological Congress Proceedings: Mexico City (1956), Sec. 3, p. 25-38.
- Phillipi, G.T., 1965, On the depth, time, and mechanism of petroleum generation: Geochim. Cosmochim. Acta, v. 29, p. 1021.
- Postuma, J. A., 1971, Manual of Planktonic Foraminifera: New York, Elsevier, 420 p.
- Pusey, W. C., III, 1973, The ESR-kerogen method--how to evaluate potential gas and oil source rocks: World Oil, v. 176, no. 5, p. 71-75.

- Reinhardt, P., 1966, Zur taxonomie and biostratigraphie des fossilen nannoplanktons aus dem Malm, der Kreide und dem Alttertiar Mitteleuropas [Taxonomy and biostratigraphy of Malm, Cretaceous, and early Tertiary nannoplanktonic faunas of central Europe], Frieberger Forschungshefte, Reihe C: Geowissenschaften, Mineralogie-Geochemie, 196 Paleont.: Leipzig, Bergakademie Freiberg, p. 5-61.
- Ricciardi, K. (ed.), 1989, Exxon Lydonia Canyon 133-1 Well, Geological and Operational Summary: Minerals Management Service OCS Report MMS 89-0007, 46 p.
- Riding, J. B., 1984, Dinoflagellate cyst range-top biostratigraphy of the uppermost Triassic to lowermost Cretaceous of northwest Europe: *Palynology*, v.8, p. 195-210.
- Robbins, E. I. and E. C. Rhodehamel, 1976, Geothermal gradients help predict petroleum potential of Scotian Shelf: *Oil & Gas Journal*, v. 74, no. 9, p. 143-145.
- Rona, P. A., 1973, Relations between rates of sediment accumulation on continental shelf, sea-floor spreading, and eustasy inferred from central North Atlantic: *Geological Society of America Bulletin*, v. 84, no. 9, p. 2851-2872.
- Ryan, W. B. F., M. B. Cita, R. L. Miller, D. Hanselman, B. Hecker, and M. Nibbelink, 1978, Bedrock geology in New England submarine canyons: *Oceanologia Acta*, v. 1, no. 2, p. 233-254.
- Sarjeant, W. A. S., 1979, Middle and Upper Jurassic dinoflagellate cysts--the world excluding North America: *American Association of Stratigraphic Palynologists Contributions Series no. 5-B*, p. 133-157.
- Schlee, J. S., J. C. Behrendt, J. A. Grow, J. M. Robb, R. E. Mattick, P. T. Taylor, and B. J. Lawson, 1976, Regional geologic framework off northeastern United States: *American Association of Petroleum Geologists Bulletin*, v. 60, no. 6, p. 926-951.
- Schlee, J. S., W. P. Dillon, and J. A. Dillon, 1979, Structure of the continental slope off the eastern United States, *in* L. J. Doyle and O. H. Pilkey, (eds.), *Geology of Continental Slopes: Society of Economic Paleontologists and Mineralogists Special Publication 27*, p. 95-117.
- Schlee, J.S. and K.D. Klitgord, 1988, Georges Bank basin: a regional synthesis; *in* R.E. Sheridan and J.A. Grow (eds.), *The Geology of North America*, vol. I-2, *The Atlantic Continental Margin*, Geological Society of America, p. 243-268.
- Schlee, J. S., R. G. Martin, R. E. Mattick, W. P. Dillon, and M. M. Ball, 1977, Petroleum geology of the U. S. Atlantic--Gulf of Mexico margins, *in* V. S. Cameron (ed.), *Exploration and Economics of the Petroleum Industry--New Ideas, Methods, New Developments: Southwestern Legal Foundation: New York, Mathew Bender and Co.*, v. 15, p. 47-93.
- Schlee, J. S., R. E. Mattick, D. J. Taylor, O. W. Girard, E. C., Rhodehamel, W. J. Perry, and K. C. Bayer, 1975, Sediments, structural framework, petroleum potential, environmental conditions and operation considerations of the United States North Atlantic Outer Continental Shelf: U. S. Geological Survey, Open-File Report 75-353, 179 p.
- Scholle, P. A. and C. R. Wenkam (eds.), 1982, Geological studies of the COST Nos. G-1 and G-2 wells, United States North Atlantic OCS: U. S. Geological Survey Circular 861, 193 p.
- Schultz, L. K. and R. L. Grover, 1974, Geology of Georges Bank Basin: *American Association of Petroleum Geologists Bulletin*, v. 58, no. 6, p. 1159-1168.

- Schwab, K.W., P. van Gijssel, and M.A. Smith, 1990, Kerogen evolution and microscopy workshop short course, International Symposium on Organic Petrology, Zeist, the Netherlands, January 10 and 11, 1990 (unpublished).
- Shell Canada Limited, 1970a, Well history report, Oneida O-25, 50 p.
- Shell Canada Limited, 1970b, Well history report, Mohawk B-93, 25 p.
- Shell Canada Limited, 1972, Well history report, Mohican I-100, 76 p.
- Sheridan, R. E., 1974a, Conceptual model for the block-fault origin of the North American Atlantic continental margin geosyncline: *Geology*, v. 2, no. 9, p. 465-468.
- Sheridan, R. E., 1974b, Atlantic continental margin of North America, *in* C. A. Burk and C. L. Drake, (eds.), *Geology of Continental Margins: New York*, Springer-Verlag, p. 391-407.
- Sheridan, R. E., 1976, Sedimentary basins of the Atlantic margin of North America: *Tectonophysics*, v. 36, p. 113-132.
- Sherwin, D. F., 1973, Scotian Shelf and Grand Banks, *in* R. G. McCrossan (ed.), *Future Petroleum Provinces of Canada--Their Geology and Potential: Canadian Society of Petroleum Geologists Memoir 1*, p. 519-559.
- Singh, C., 1971, Lower Cretaceous microfloras of the Peace River area, northwestern Alberta: *Research Council of Alberta Bulletin 28*, 2 volumes, 542 p.
- Smith, H. A., 1975, Geology of the West Sable structure: *Bulletin of Canadian Petroleum Geology*, v. 23, no. 1, p. 109-130.
- Smith, M. A., 1979, Geochemical analysis, *in* R. V. Amato and E. K. Simonis (eds.), *Geologic and Operational Summary, COST No. B-3 Well, Baltimore Canyon Trough Area, Mid-Atlantic OCS: U. S. Geological Survey Open-File Report 79-1159*, p. 81-99.
- Smith, M. A., 1980, Geochemical analysis, *in* R.V. Amato and E.K. Simonis (eds.), *Geologic and Operational Summary, COST No. G-2 Well, Georges Bank Area, North Atlantic OCS: U. S. Geological Survey Open-File Report, 80-269*, p. 77-99.
- Smith, M. A., 1995, Assessment of U.S. Atlantic hydrocarbon resources using new geochemical technology: U.S. Geological Society of America, Abstracts with programs, 1995 Annual Meeting, New Orleans, LA.
- Smith, M.A., R.V. Amato, M.A. Furbush, D.M. Pert, M.E. Nelson, J. S. Hendrix, L.C. Tamm, G. Wood, Jr., and D.R. Shaw, 1976, *Geological and Operational Summary, COST No. B-2 Well, Baltimore Canyon Trough Area, Mid-Atlantic OCS: U. S. Geological Survey Open-File Report 76-774*, 79 p.
- Smith, M. A. and D. R. Shaw, 1980, Geochemical analysis, *in* R. V. Amato and J. W. Bebout (eds.), *Geologic and Operational Summary, COST No. G-1 well, Georges Bank Area, North Atlantic OCS: U. S. Geological Survey Open-File Report 80-268*, p. 81-94.

- Smith, M.A., and P. van Gijzel, 1990, New perspectives on the depositional and thermal history of Georges Bank; *in* W.J.J. Fermont and J.W. Weegink (eds.), Proceedings, International Symposium on Organic Petrology, Zeist, the Netherlands.
- Smith, R. A., J. R. Stack, and R. K. Davis, 1976, An oil spill risk analysis for the Mid-Atlantic Outer Continental Shelf lease area: U. S. Geological Survey Open-File Report 76-451, 24 p.
- Staplin, F. L., 1969, Sedimentary organic matter, organic metamorphism, and oil and gas occurrence: Bulletin of Canadian Petroleum Geology, v. 17, no. 1, p. 47-66.
- Steinkraus, W. E., 1980, Biostratigraphy, *in* R. V. Amato and J. W. Bebout, (eds.), Geologic and Operation Summary, COST No. G-1 Well, Georges Bank, North Atlantic OCS: U. S. Geological Survey Open-File Report 80-268, p. 39-51.
- Stewart, H. B., Jr. and G. F. Jordan, 1964, Underwater sand ridges on Georges Shoal, *in* R. L. Miller (ed.), Papers in Marine Geology, Shepard Commemorative Volume: New York, Macmillan, p. 102-114.
- Tamm, L. C., 1978, Electric log interpretations, *in* R. V. Amato and J. W. Bebout (eds.), Geological and Operational Summary, COST No. GE-1 Well, Southeast Georgia Embayment Area, South Atlantic OCS: U. S. Geological Survey Open-File Report 78-668, 61-75.
- Thierstein, H. R., 1971, Tentative Lower Cretaceous calcareous nannoplankton zonation: *Eclogae Geologicae Helveticae*, v. 64, p. 459-487.
- Tissolt, B. P. and D. H. Welte, 1978, Petroleum Formation and Occurrence, A New Approach to Oil and Gas Exploration: Berlin, Springer-Verlag, p. 123-201.
- Tissot, B., B. Durand, J. Espitalie, and A. Combaz, 1974, Influence of nature and diagenesis of organic matter in formation of petroleum: American Association of Petroleum Geologists Bulletin, v. 58, no. 3, p. 499-506.
- Tschudy, R. H., 1973, *Complexiopollis* Pollen Lineage in Mississippi Embayment Rocks: U. S. Geological Survey Professional Paper 743-C, p. C1-C15.
- Uchupi E. and K. O. Emery, 1967, Structure of continental margin off Atlantic coast of United States: American Association of Petroleum Geologists Bulletin, v. 51, no. 2, p. 223-234.
- U. S. Department of Commerce, 1973, Environmental Conditions within Specified Geographical Regions-- Offshore East and West Coast of the United States and in the Gulf of Mexico: Washington, D. C., National Oceanographic Data Center, National Oceanographic and Atmospheric Administration, 735 p.
- Van Gijzel, P., 1990, Transmittance colour index (TCI) of amorphous organic matter: a new thermal maturity indicator for hydrocarbon source rocks, and its correlation with mean vitrinite reflectance and thermal alteration index (TAI); *in* W.J.J. Fermont and J.W. Weegink, eds., Proceedings, International Symposium on Organic Petrology, Zeist, the Netherlands.
- Van Hinte, J. E., 1976a, A Jurassic time scale: American Association of Petroleum Geologists Bulletin, v. 60, no. 4, p. 489-497.

- Van Hinte, J. E., 1976b, A Cretaceous time scale: American Association of Petroleum Geologists Bulletin, v. 60, no. 4, p. 498-516.
- Vassoyevich, N. B., Yu. I. Korchagina, N. V. Lopatin, and V. V. Chernyshev, 1969, Glavanaya faza nefteobrazovaniya [Principal phase of oil formation]: Moskovskogo Universiteta Vestnik, Ser. 4, Geologii, v. 24, no. 6, p. 3-27: English translation *in* International Geology Review, 1970, v. 12, no. 11, p. 1,276-1,296.
- Wade, J.A., 1977, Stratigraphy of Georges Bank Basin-- interpretation from seismic correlation to the western Scotian Shelf: Canadian Journal of Earth Science, v. 14, no. 10, p. 2274-2283.
- Wade, J.A., G.R.Campbell, R.M. Proctor, and G.C. Taylor, 1989, Petroleum Resources of the Scotian Shelf, Geological Survey of Canada Paper 88-19.
- Walper, J. L. and R. E. Miller, 1985, Tectonic evolution of Gulf Coast basins, *in* B. F. Perkins and G. B. Martin (eds.), Habitat of Oil and Gas, Program and Abstracts, Fourth Annual Research Conference, Gulf Coast Section: Austin, Society of Economic Paleontologists and Mineralogists Foundation, Earth Enterprises, p. 25-42.
- Waples, D. W., 1980, Time and temperature in petroleum formation--application of Lopatin's method to petroleum exploration: American Association of Petroleum Geologists Bulletin, v. 64, no. 6, p. 916-926.
- Weed, E. G. A., J. P. Minard, W. J. Perry, Jr., E. C. Rhodehamel, and E. I. Robbins, 1974, Generalized pre-Pleistocene geologic map of the northern United States Atlantic continental margin: U. S. Geological Survey Miscellaneous Geologic Investigations Map I-861, Scale 1:1,000,000.
- Williams, G. L., 1974, Dinoflagellate and spore stratigraphy of the Mesozoic-Cenozoic offshore Eastern Canada, *in* Offshore Geology of Eastern Canada: Geological Survey of Canada Paper 74-30, v. 2, p. 107-161.
- Williams, G. L., 1977, Dinocysts--their classification, Biostratigraphy, and paleoecology, *in* A. T. S. Ramsay (ed.), Oceanic Micropaleontology, v. 2, New York, Academic Press, p. 1,231-1,326.
- Williams, G. L. and W. W. Brideaux, 1975, Palynologic analyses of Upper Mesozoic and Cenozoic rocks of the Grand Banks, Atlantic Margin: Geological Survey of Canada Bulletin, v. 236, p. 1-163.
- Woollam, R. and J. B. Riding, 1983, Dinoflagellate cyst zonation of the English Jurassic: Institute of Geological Sciences Report, v. 83, No. 2, p. 1.
- Worsley, T. R., 1971, Calcareous nannofossil zonation of Upper Jurassic and Lower Cretaceous sediments from the Western Atlantic, *in* Proceedings II, International Planktonic Conference, Roma, 1970: Rome, Edizioni Tecnoscienza, p. 1,301-1,321 .